

Sentry Plus Hipot Tester Instruction Manual

Form 150697/A9

©QuadTech, Inc., 2003, 2007
5 Clock Tower Place, 210 East
Maynard, Massachusetts, U.S.A. 01754
March 2008

Telephone: 978-461-2100
Sales: 800-253-1230
Facsimile: 978-461-4295
Website: www.quadtech.com

The material in this manual is for informational purposes only and is subject to change, without notice. QuadTech assumes no responsibility for any error or for consequential damages that may result from the misinterpretation of any procedures in this publication.

WARNING

Potentially dangerous voltages may be present on front and rear panel terminals. Follow all warnings in this manual when operating or servicing this instrument. Dangerous levels of energy may be stored in capacitive devices tested by this unit. Always make sure the high voltage indicator is **not** on when connecting or disconnecting the device under test.

Contents

Warranty	5
Specifications	7
Accessories	11
Safety Precautions	13
Condensed Operating Instructions	15

Introduction - Section 1

1.1	Unpacking and Inspection	21
1.2	Product Overview	21
1.3	Controls and Indicators	22
1.3.1	Front Panel Controls and Indicators	22
1.3.2	Rear Panel Controls and Connectors	23
1.4	Installation	24
1.4.1	Dimensions	24
1.4.2	Instrument Positioning	24
1.4.3	Power Requirements	24
1.4.4	Safety Inspection	25

Operation - Section 2

2.1	Terms and Conventions	27
2.2	Start-Up	31
2.3	Programming Electrical Safety Tests	31
2.4	Programming a Ground Continuity Test	35
2.5	Programming an Open/Short Circuit (OS) Check	37
2.6	Programming an AC Hipot Test	39
2.7	Programming a DC Hipot Test	41
2.8	Programming a Pause (PA) in the Test Sequence	43
2.9	Programming an Insulation Resistance (IR) Test	45
2.10	Storing a Test Setup	47
2.11	Programming a Multi-Step Test	49
2.12	PRESET Test Parameters	50
2.12.1	AC-V FREQ	50
2.12.2	Software AGC	50
2.12.3	WV AUTO RANGE	50
2.12.4	IR AUTO RANGE	51
2.12.5	GFI	51
2.12.6	FAIL RESTART	51
2.13	Instrument Offset	52
2.14	Connection To Device Under Test	56
2.15	Measurement Procedure	57
	FAIL messages	59

Contents (Continued)

2.16	MENU Parameters	59
2.16.1	MEMORY Function	60
2.16.2	SYSTEM Function	62
2.16.2.1	CONTRAST	62
2.16.2.2	BUZZER VOLUME	62
2.16.2.3	EN 50191	62
2.16.2.4	DC 50V AGC	63
2.16.3	OPTION Function	63
2.16.4	CALIBRATION Function	63
2.16.5	KEY LOCK Function	63
2.16.6	CHANGE PASSWORD Function	65
2.16.7	ERROR LOG Function	66
2.16.8	ABOUT Function	67

Interface - Section 3

3.1	Remote	69
3.2	G16 International Power Strip	72
3.3	S07 Power Entry Adapter Cable	73
3.4	S03 Corded Product Adapter	74
3.5	S05 Foot Switch	75
3.6	S08 Gun Probe	76
3.7	S50 Plus Ground Bond Tester	77

Service & Calibration - Section 4

4.1	General.....	79
4.2	Instrument Return	79
4.3	Calibration.....	79
4.3.1	Calibration Parameters.....	80
4.3.2	Enable Calibration	81
4.3.3	AC Voltage Calibration	82
4.3.4	DC Voltage Calibration	82
4.3.5	IR Voltage Calibration.....	83
4.3.6	AC Current Calibration.....	84
4.3.7	DC Current Calibration.....	85
4.3.8	ARC Calibration	86
4.3.9	IR Resistor Calibration	86
4.3.10	Ground Continuity Calibration	87
4.3.11	Contrast Calibration	87
4.3.12	Finalize Calibration	87

Warranty



QuadTech warrants that Products are free from defects in material and workmanship and, when properly used, will perform in accordance with QuadTech's applicable published specifications. If within one (1) year after original shipment it is found not to meet this standard, it will be repaired, or at the option of QuadTech, replaced at no charge when returned to a QuadTech service facility.

Changes in the Product not approved by QuadTech shall void this warranty.

QuadTech shall not be liable for any indirect, special or consequential damages, even if notice has been given of the possibility of such damages.

This warranty is in lieu of all other warranties, expressed or implied, including, but not limited to any implied warranty or merchantability of fitness for a particular purpose.

SERVICE POLICY

QuadTech's service policy is to maintain product repair capability for a period of at least five (5) years after original shipment and to make this capability available at the then prevailing schedule of charges.

Specifications

Dielectric Strength

Sentry 10, 20, & 30 Plus

AC Output Voltage:	Range: 0.05 to 5kV AC, in 1V steps Regulation: \pm (1% of setting +5V) Frequency: 50/60Hz selectable
Voltage Display:	Accuracy: \pm (1% of reading +5V) Resolution: 1Volt
AC Current Display:	Range: 0.001mA to 20mA AC, in 1 μ A steps Accuracy: \pm (1.5% of reading + 5 counts) (Total)

Sentry 20 & 30 Plus

DC Output Voltage:	Range: 0.05 to 6kV DC, in 1V steps
Voltage Display:	Accuracy: \pm (1% of reading +5V) Resolution: 1Volt
DC Current Display:	Range: 0.0001mA to 5mA DC Resolution: 0.1 μ A Accuracy: \pm (1.5% of reading + 5 counts)

Insulation Resistance

Sentry 30 Plus

Insulation Resistance:	Voltage: 50 - 1000V DC in 1V steps Accuracy: \pm (1% of reading + 5V) Range: 0.1M Ω - 50G Ω (voltage dependent) Accuracy: 0.1M Ω - 1G Ω , \pm (10% + 5counts) < 100V 0.1M Ω - 1G Ω , \pm (7% + 5counts) < 500V 1M Ω - 1G Ω , \pm (4% + 5counts) \geq 500V 1G Ω - 10G Ω , \pm (7% + 5counts) \geq 500V 10G Ω - 50G Ω , \pm (12% + 5counts) \geq 500V
-------------------------------	--

Open/Short Check (OSC)

Sentry 10, 20 & 30 Plus

Open/Short:	Detection mode to verify proper connection of DUT
	Voltage: < 100V
	Frequency: 600Hz
	Open: programmable: 10% - 100%, default: 50%
	Short: programmable: 100% - 500%, default: 300%

Specifications (Continued)

Safety Features

Ground

Continuity Test: Programmable: 0.1Ω to $5.0\Omega \pm 0.2\Omega$ Accuracy, or OFF

Ground Fault

Interrupt (GFI): Shutdown of current imbalance when $I > 0.5\text{mA} \pm 0.25\text{mA}$, or OFF

In-Rush Current:

DC Mode: Set detection limit: $0.5\mu\text{A} - 5\text{mA}$ in 0.0001mA increments
The programmable range for In-Rush current is dependent on the programmed High Limit:

Range:	High Limit:	In-Rush:
1	$0.1\mu\text{A} - 300\mu\text{A}$	$0.5\mu\text{A} - 300\mu\text{A}$
2	$0.301\text{mA} - 3.000\text{mA}$	$5\mu\text{A} - 3.000\text{mA}$
3	$3.01\text{mA} - 5.0\text{mA}$	$50\mu\text{A} - 5.0\text{mA}$

Fast Output Cutoff: HV output voltage terminated $< 0.4\text{mS}$ after NG (Fail) result

Fast Discharge: $< 0.2\text{s}$ (Typical) Discharge of DUT upon termination of HV.

ARC Detection: Detection Current: Range: $1\text{mA} - 20\text{mA}$ AC and 5mA DC
Pulse Width: Minimum: $10\mu\text{s}$

General Features

Time:

Test*: $0.1\text{sec} - 999\text{sec}$, Continuous
Ramp: $0.1\text{sec} - 999\text{sec}$, OFF
Dwell: $0.1\text{sec} - 999\text{sec}$, OFF (DC & IR Mode only)
Fall: $0.1\text{sec} - 999\text{sec}$, OFF

* Test Time is limited $\leq 60\text{seconds}$ when the voltage and high current limit $> 100\text{VA}$.

* Test Time for IR is $0.3\text{sec} - 999\text{sec}$, Continuous

Limits:

HI/LO programmable during Test Time
LO can be set to OFF during Hipot Test
HI can be set to OFF during IR Test

Indication:

Pass/fail LEDs, audible alarm

Remote Control:

Inputs: START, STOP
Characteristics: 24V active low, Pulse width $\cong 20\text{ms}$
Outputs: PASS, FAIL, UNDER TEST
Characteristics: Dry contact relay, Closed if true
 115V , $< 100\text{mA}$
Connector: 9 pin male D-series & Terminal Strip

Specifications (Continued)

General Features

Setup Storage: 60 Memory Locations, 10 steps each

Standard Interfaces: Remote I/O

Connectors: Front and Rear Connection
HV OUTPUT: Custom Banana Socket
RTN/LOW: Banana Socket
GC (Rear Only): Binding Post/Banana Socket

Front Panel Lockout: 10 Digit Password with or without setup recall
LED Display: LOCK

Mechanical: Bench Mount
Dimensions: (w x h x d):262.5 x 112.5 x 356.25 mm

Weight: 11.5 kg net, 13.0 kg shipping

Environmental: Specifications: 18°C to 28°C, 70% RH
Operating: 0°C to + 40°C, 80% RH
Storage: -10°C to + 60°C, 80% RH
Warm-up Time: 15 minutes

Power: • 90 - 130V AC • 50 or 60Hz
 • 200 - 250V AC • 300W max

Supplied: • Instruction Manual • Power Cable
 • Calibration Certificate • S02 Test Leads
 • Ground Continuity Lead

Safety Agency: CE, TUV

Ordering Information:	<u>Description</u>	<u>Catalog No.</u>
	AC Hipot Tester	Sentry 10 Plus
	AC/DC Hipot Tester	Sentry 20 Plus
	AC/DC/IR Hipot Tester	Sentry 30 Plus

Note 1: AC set over 75 VA, DC set over 22.5 VA the maximum operating time is 60 seconds, the same as rest time. If the period is 1/2 duty (TUV ON), for full rating output, the line input range is +10%, -0%.

Accessories

Accessories Included

Item	Quantity	QuadTech P/N
AC Power Cord	1	4200-0300
Power Line Fuse 3.15A 250V SB	1	520072
Power Line Fuse 1.6A 250V SB	1	520074
High Voltage Lead Set, 1m with alligator clips	1	S02
Ground Continuity Lead	1	700100
Instruction Manual	1	150697
Calibration Certificate	1	N/A

Accessories/Options Available

Item	Quantity	QuadTech P/N
High Voltage Lead Set, high & low, 1m (std. with unit)	1	S02
Corded Product Adaptor, 115V	1	S03
High Voltage Lead Set, high & low, 2m	1	S04
Foot Switch	1	S05
High Voltage Probe	1	S06
Power Entry Adaptor Cable	1	S07
Gun Probe	1	S08
High Voltage Lead, 1m, unterminated	1	S09
High Voltage Lead, 2m, unterminated	1	S10
Gun Probe with Remote Start	1	S11
Load Box, resistive	1	S12
Load Box, custom resistors	1	S14
Interconnection Cable to Sentry 50 Ground Bond Tester	1	S15
Ground Continuity Lead (standard with unit)	1	700100
International Power Strip	1	G16
Corded Product Adaptor, 240V	1	G25

Safety Precautions

WARNING

The Sentry Plus Series Hipot Tester can provide an output voltage as high as 6000V DC (5000V AC) to the external device under test (DUT). Although the Sentry Plus unit is designed with full attention to operator safety, serious hazards could occur if the instrument is used improperly and these safety instructions are not followed.

1. The Sentry Plus unit is designed for operation with its chassis connected to earth ground. The instrument is shipped with a three-prong power cord to provide this connection to ground. This power cord should only be plugged in to a receptacle that provides earth ground. Serious injury can result if the Sentry Plus is not connected to earth ground.
2. Tightly connect cable(s) to the (blue) **RTN/LOW** terminal. If this is not done, the DUT's casing can be charged to the high voltage test level and serious injury or electrical shock hazards could result if the DUT is touched.
3. Never touch the metal of the High Voltage probe directly. Touch only the insulated parts of the lead(s).
4. Never touch the test leads, test fixture or DUT in any manner (this includes insulation on all wires and clips) when the high voltage is applied and the red **DANGER** light is **ON**.
5. Before turning on the Sentry Plus unit, make sure there is no device (DUT) or fixture connected to the test leads.
6. After each test, press the **[STOP]** (red) button for safety if there is any concern that HV may still be applied to the output terminals.
7. When the red **DANGER** LED is lit or flashing, NEVER touch the device under test, the lead wires or the output terminals.
8. Before touching the test lead wires or output terminals make sure:
 - a) The red **[STOP]** button has been pressed
 - b) The red **DANGER** LED is **OFF**.
9. **In the case of an emergency**, turn **OFF** the **POWER** switch using a "hot stick" and disconnect the AC power cord from the wall. **DO NOT TOUCH THE Sentry Plus INSTRUMENT.**
Position the equipment so it is easy to disconnect. Disconnect by means of the power plug or the power connector.
10. If the **DANGER** LED does not go **off** when the **[STOP]** button is pressed, immediately stop using the tester. It is possible that the output voltage is still being delivered regardless of the **TEST ON/OFF** control signal.
11. When the Sentry Plus instrument is used in remote control mode, be extremely careful. The High Voltage Output is being turned on and off with an external signal.

Safety Symbols

The product is marked with the following safety symbols.



Product will be marked with this symbol (ISO#3864) when it is necessary for the user to refer to the instruction manual in order to prevent injury or equipment damage.



Product marked with this symbol (IEC417) indicates presence of direct current.



Product will be marked with this symbol (ISO#3864) when voltages in excess of 1000V are present.



Indicates the grounding protect terminal, which is used to prevent electric shock from the leakage on chassis. The ground terminal must connect to earth before using the product.

Warning Procedure can cause hazard to human if the warning is neglected.

Caution Avoid product misuse. It may cause damage to the product itself and the DUT if the caution is neglected.

Note Important information or tips for the procedures and applications.

Warning Signal During Testing

“DANGER – HIGH VOLTAGE TEST IN PROGRESS, UNAUTHORIZED PERSONS KEEP AWAY”

Disposal

Do not dispose of electrical appliances as unsorted municipal separate collection facilities. Contact your local government for information regarding the collection systems available. If electrical appliances are disposed of in landfills or dumps, hazardous substances can leak into the groundwater and get into the food chain, damaging your health and well-being. When replacing old appliances with new one, the retailer is legally obligated to take back your old appliances for disposal.



waste, use

Condensed Operating Instructions

WARNING

High Voltage is applied to the white HV Output Terminal anytime the red **DANGER** LED is **ON** or flashing. Always make sure the **DANGER** LED is **OFF** when connecting or disconnecting the device under test (DUT).

General Information

The Sentry Plus Series Hipot Tester is a measuring instrument for direct readout of hipot output voltage and leakage current and insulation resistance. The voltage applied to the device under test is adjustable from 50V to 5kV AC and 50V to 6kV DC. The trip current limit is programmable from 1uA to 20mA AC in 1uA steps and from 0.1uA to 5mA DC in 0.1uA steps. The output voltage for Insulation Resistance tests is 50V to 1000V DC over a measurement range of 100k Ω to 50G Ω . The Open/Short Circuit (OS) detection mode verifies the proper connection of the DUT by comparing the test reading to a standard capacitance value, Cs.

Start-Up

The Sentry Plus Series unit can be operated from a power source between 90 and 250VAC at a power line frequency of 50 or 60Hz. The standard Sentry Plus Series unit is shipped from QuadTech with a 3.15A fuse in place for AC 90-130V operation. (A 1.6A fuse is included for 200-250V operation). The Sentry Plus unit is shipped with the line voltage selector set for 120V. Refer to paragraph 1.4.3 for instructions on changing the fuse or line voltage selector.

Connect the Sentry Plus Series unit AC power cord to the source of proper voltage. Operate the Sentry Plus Series instrument with its chassis connected to earth ground. The Sentry Plus instrument is shipped with a three-prong power cord to provide this connection to ground. This power cord should only be plugged into a receptacle that provides earth ground. Serious injury may result if the Sentry Plus Series instrument is not connected to earth ground.

Press the [POWER] button on the front panel to apply power. To switch the power off, press the [POWER] button again or if measurements are to be made proceed with the Test Parameter Setup in Table COI-1. The Sentry Plus Series instrument should warm up for 15 minutes prior to use.

NOTE

Please read this instruction manual in its entirety before operating this instrument. These condensed operating instructions are not a substitute for all the information provided in the remainder of this manual.

NOTE

Refer to paragraphs 2.3 through 2.9 for a full description of programming test parameters and instruction on how to store the test setup. Test parameters must be set before the Sentry Plus Series instrument can be zeroed.

Condensed Operating Instructions (Continued)

There are numerous menus within the Sentry Plus Series instruments. Familiarize yourself with these menus prior to programming a test. Figure COI-1 illustrates the STAND BY display and lists the functions that can be accessed by pressing the [F1] through [F4] keys.

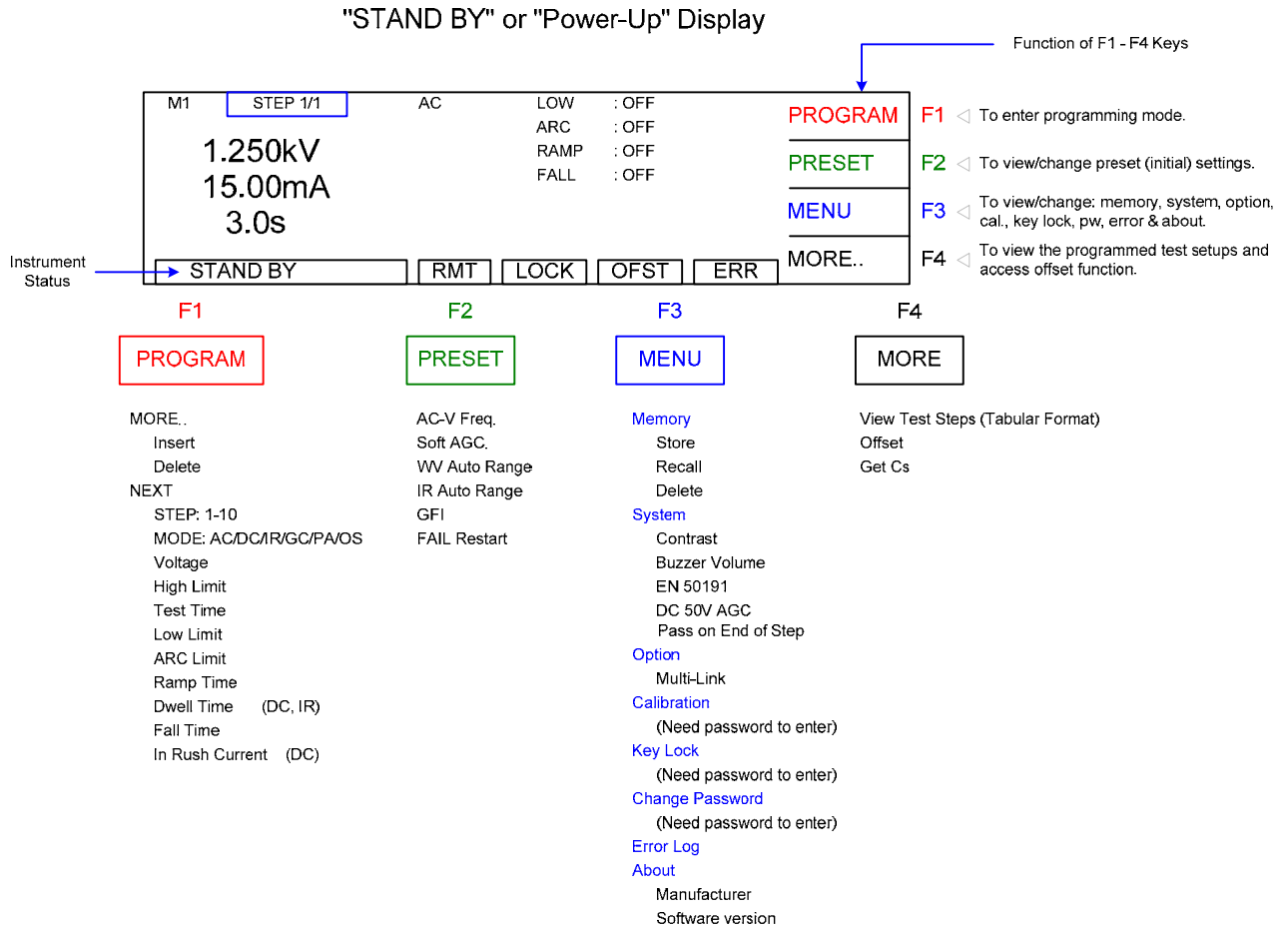

Figure COI-1: Sentry Plus Series Menus

Condensed Operating Instructions (Continued)

With the Sentry Plus Series instrument in “STAND BY” (or power-up display) status, follow the steps in Table COI-1 to program an AC, DC, IR or GC test or insert a Pause in the test sequence.

PROGRAM MODE DISPLAYS	"STAND BY" DISPLAY	STEP 1/1 AC LOW : OFF ARC : OFF RAMP : OFF FALL : OFF	PROGRAM PRESET MENU MORE..	F1 ◀ To enter programming mode. F2 ◀ To view/change preset (initial) test parameters. F3 ◀ To view/change system parameters: memory, system, option, cal, key lock, pw, error & about. F4 ◀ To view the programmed test setups and access offset function.
	AC Display	STEP 1/1 AC LOW : OFF ARC : OFF RAMP : OFF FALL : OFF VOLT : 0.000kV HIGH : 0.500mA TIME : 3.0s	UP DOWN NEXT EXIT	F1 ◀ To change value in highlighted box. F2 ◀ To toggle choices of highlighted box. F3 ◀ To move highlighted box around display to select parameter to change F4 ◀ To exit programming mode.
	DC Display	STEP 1/1 DC LOW : OFF ARC : OFF RAMP : OFF DWELL : OFF FALL : OFF I-RUS : OFF VOLT : 0.000kV HIGH : 0.500mA TIME : 3.0s	UP DOWN NEXT EXIT	F1 ◀ To select mode: AC/DC/IR/GC/PA/OS F2 F3 F4
	IR Display	STEP 1/1 IR HIGH : OFF RAMP : OFF DWELL : OFF FALL : OFF VOLT : 0.000kV LOW : 1.0MΩ TIME : 3.0s	UP DOWN NEXT EXIT	F1 ◀ To select mode: AC/DC/IR/GC/PA/OS F2 F3 F4
	GC Display	STEP 1/1 GC LOW : OFF RAMP : OFF DWELL : OFF CURR : 0.0A HIGH : 1.0Ω DWELL : 3.0s	UP DOWN NEXT EXIT	F1 ◀ To select mode: AC/DC/IR/GC/PA/OS F2 F3 F4
	PA Display	STEP 1/1 PA PAUSE : PAUSE MODE UNDER TEST SIGNAL : OFF	UP DOWN NEXT EXIT	F1 ◀ To select mode: AC/DC/IR/GC/PA/OS F2 F3 F4
	OS Display	STEP 1/1 OS OPEN : 50% SHORT : 300%	UP DOWN NEXT EXIT	F1 ◀ To select mode: AC/DC/IR/GC/PA/OS F2 F3 F4

Figure COI-2: “STAND BY” and PROGRAM Displays

Condensed Operating Instructions (Continued)

Table COI-1: Test Parameter Setup

Step	Test Parameter	AC Hipot	DC Hipot	IR	GC	OS	Range
1	To enter programming mode	[F1] = PROGRAM	[F1] = PROGRAM	[F1] = PROGRAM	[F1] = PROGRAM	[F1] = PROGRAM	
2	Select Test Step	[F1] = UP [F3] = NEXT	[F1] = UP [F3] = NEXT	[F1] = UP [F3] = NEXT	[F1] = UP [F3] = NEXT	[F1] = UP [F3] = NEXT	1-10
3	Select Test Mode	[F1] = UP [F3] = NEXT	[F1] = UP [F3] = NEXT	[F1] = UP [F3] = NEXT	[F1] = UP [F3] = NEXT	[F1] = UP [F3] = NEXT	AC, DC, IR, GC, PA, OSC
4	Set Test Voltage Set Current (GC) Set Open % (OSC)	[F1] = INC. [F3] = NEXT	[F1] = INC. [F3] = NEXT	[F1] = INC. [F3] = NEXT	[F1] = INC. [F3] = NEXT	[F1] = INC. [F3] = NEXT	0.05-5kV AC 0.05-6kV DC 0.05-1kV IR 0.1A GC 10-100% OSC
5	Set High Limit * Set Low Limit (IR) Set Short % (OSC)	[F1] = INC. [F3] = NEXT	[F1] = INC. [F3] = NEXT	[F1] = INC. [F3] = NEXT	[F1] = INC. [F3] = NEXT	[F1] = INC. [F3] = NEXT	0.001-20mA AC 0.0001-5mA DC 0.1-50000MΩ IR 0, 0.1-5ΩGC 100-300% OSC
6	Set Test Time Set Dwell (GC) ***	[F1] = INC. [F3] = NEXT	[F1] = INC. [F3] = NEXT	[F1] = INC. [F3] = NEXT	[F1] = INC. [F3] = NEXT		0, 0.1-999s AC 0, 0.1-999s DC 0, 0.1-999s IR 0.1-1s GC
7	Set Low Limit ** Set High Limit (IR)	[F1] = INC. [F3] = NEXT	[F1] = INC. [F3] = NEXT	[F1] = INC. [F3] = NEXT	[F1] = INC. [F3] = NEXT		0-20mA AC 0-5mA DC 0-50GΩ IR 0-5ΩGC
8	Set ARC Limit	[F1] = INC. [F3] = NEXT	[F1] = INC. [F3] = NEXT				1-20mA AC 1-5mA DC
9	Set Ramp Time	[F1] = INC. [F3] = NEXT	[F1] = INC. [F3] = NEXT	[F1] = INC. [F3] = NEXT			0-999s AC 0-999s DC 0-999s IR

10	Set Dwell Time***		[F1] = INC. [F3] = NEXT	[F1] = INC. [F3] = NEXT			0-999s DC 0-999s IR
11	Set Fall Time	[F1] = INC. [F3] = NEXT	[F1] = INC. [F3] = NEXT	[F1] = INC. [F3] = NEXT			0-999s AC 0-999s DC 0-999s IR
12	Set In-Rush Current		[F1] = INC. [F3] = NEXT				0, 0.5uA-5mA DC
13a	To program next test step OR	[F1] = NEW OR	[F1] = NEW OR	[F1] = NEW OR	[F1] = NEW OR	[F1] = NEW OR	Program next step OR
13b	To exit programming mode	[F4] = EXIT	[F4] = EXIT	[F4] = EXIT	[F4] = EXIT	[F4] = EXIT	Exit programming

* High limit decision is made throughout test time.

** Unit will make low limit decision at the end of test.

*** Limits will be checked at end of dwell time.

Condensed Operating Instructions (Continued)

Offset

After setting your test parameters, zero the Sentry Plus Series instrument by using the automatic offset. With no device connected, connect the appropriate cable (or other fixture) into the OUTPUT connectors. Refer to paragraph 2.13 cable connections based on test to be performed. Return and HV test leads should not be connected together (open circuit) for AC and DC hipot tests. Return and GC test leads should be connected (short circuit) for a GC test. There is no offset in an IR test.

NOTE:

If Ground Continuity (GC) is turned ON when performing an offset, the continuity lead must be connected to the return (RTN/LOW) terminal, otherwise turn the continuity test OFF.

Prior to performing the OFFSET function:

- Allow the instrument to warm up for 15 minutes.
- Connect the Test cables (or fixture) to the front panel OUTPUT and RTN/LOW connectors.
- Program the test steps.

With the instrument in STAND BY status:

- Press [F4] = MORE
- Press [F1] = OFFSET
- Follow instructions on display: i.e.: connect OPEN across OUTPUT terminal.
- Press green [START] button.
- Wait while instrument gets OFFSET value.
- The **OFST** block at the bottom of the display is now highlighted (back lit).
- Press [F4] = MORE to return to STAND BY status.

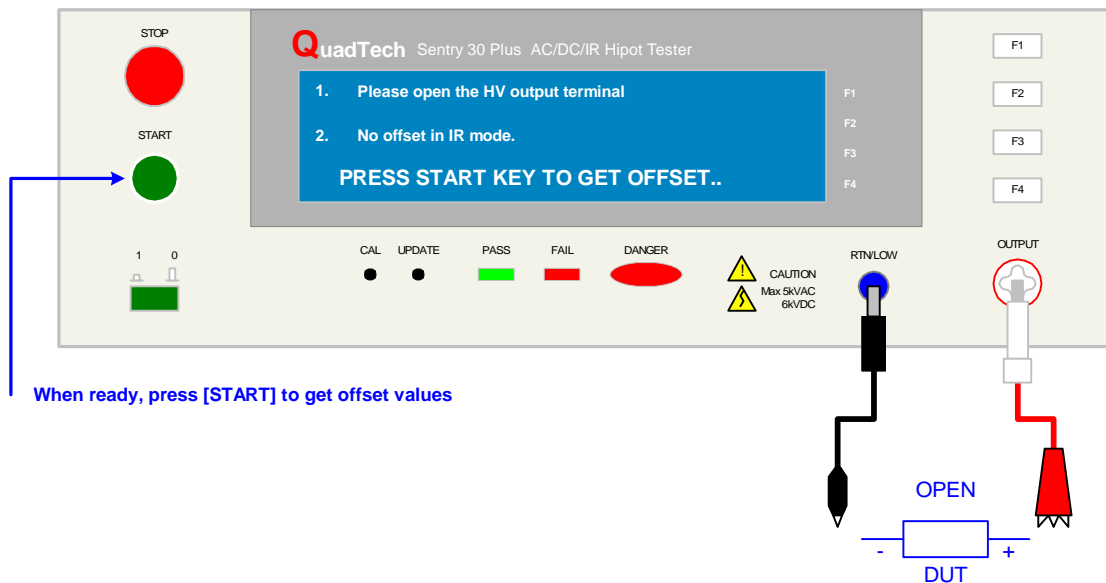
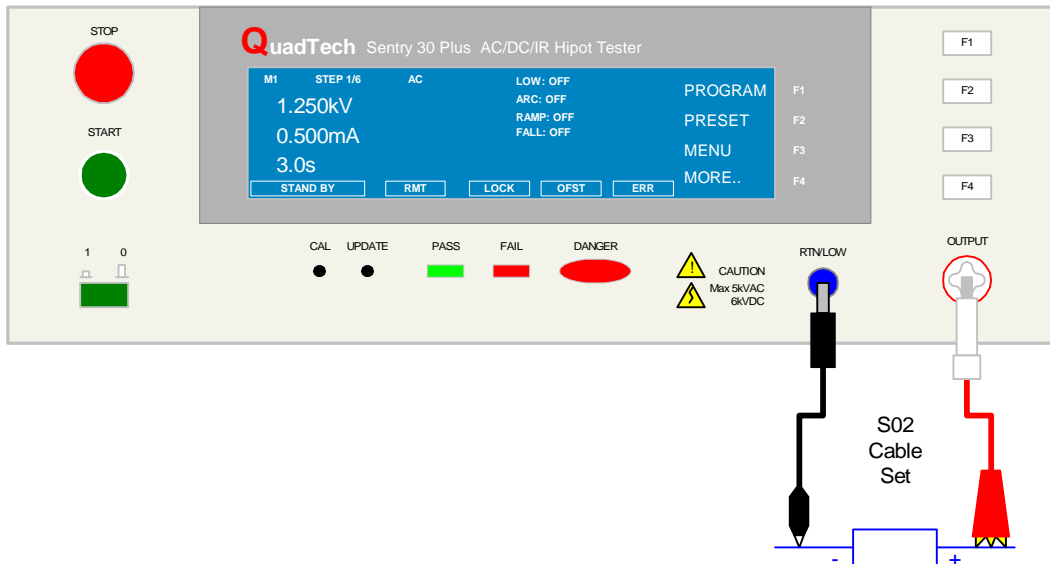

Figure COI-3: Zero/Offset OPEN Configuration

Condensed Operating Instructions (Continued)

Connection to Device under Test (DUT)

Figure COI-4 illustrates the connection of the Sentry Plus Series unit to a single DUT using the S02 1-meter HV cable set that comes standard with the instrument. The custom white banana plug/red alligator clip is connected between the OUTPUT terminal on the Sentry Plus Series unit and the high side of the device under test. The black banana plug/alligator clip is connected between the RTN/LOW terminal on the Sentry Plus Series unit to the low side of the DUT.



COI-4: Connection to Device under Test

Measurement Mode

1. Turn [POWER] ON.
2. Allow Sentry Plus Series instrument a 15-minute warm up time.
3. Connect S02 Black ground cable to Sentry Plus Series unit RTN/LOW terminal
4. Connect S02 White/red HV cable to Sentry Plus Series unit OUTPUT terminal.
5. Press [F1] = PROGRAM and enter test parameters. When finished programming, press [F4] = EXIT to return to Stand By status.
6. Press [F4] = MORE to access Offset function. Press [F1] = OFFSET. Follow Offset instructions. When Offset is complete, press [F4] = MORE to return to Stand By.
7. Press [F4] = MORE to access OSC function. Press [F2] = Get Cs. Follow Get Cs instructions. When Get Cs is complete, press [F4] = MORE to return to Stand By.
8. Connect device under test (DUT) to test leads.
9. Press [START].
10. Record measurement.
11. Press [STOP].

Section 1: Introduction

1.1 Unpacking and Inspection

Inspect the shipping carton before opening. If damaged, contact the carrier agent immediately. Inspect the Sentry Plus Series instrument for any damage. If the instrument appears damaged or fails to meet specifications notify QuadTech (refer to instruction manual front cover) or its local representative. Retain the original shipping carton and packing material for future use such as returning the instrument for recalibration or service.

1.2 Product Overview

The Sentry Plus Series is available in three models, the 10, 20 and 30, all of which provide AC Hipot testing capability. Additionally, the Sentry 20 & 30 Plus instruments provide DC Hipot testing. The Sentry 30 Plus unit provides Insulation Resistance testing. The hipot test can be programmed over a voltage range of 0.05 to 5kV AC and 0.05 to 6kV DC with a min/max leakage current detection range of 0.001 to 20mA AC and 0.0001 to 5mA DC. Insulation resistance measurements are possible to 50GΩ at programmable DC test voltages between 50 and 1000V. Each instrument comes standard with programmable ground continuity, open/short circuit detection, internal storage containing 60 memory locations (10 steps each) and a remote interface with start/stop inputs & pass/fail outputs.

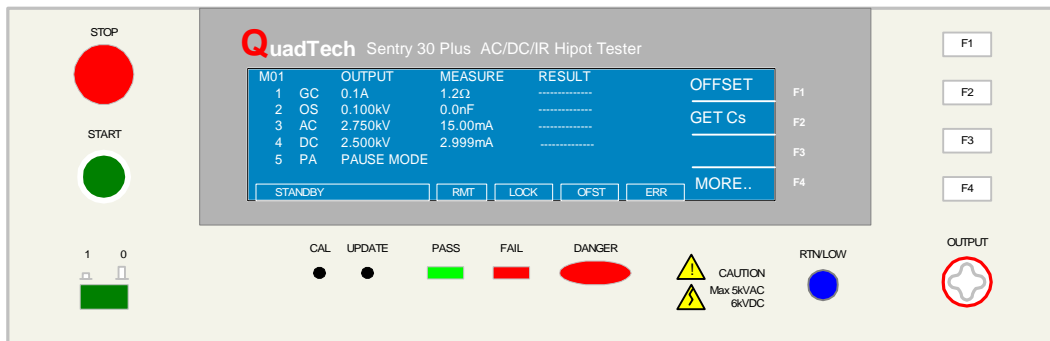

Figure 1-1: Sentry 30 Plus AC/DC/IR Hipot Tester

UL Requirements

The Sentry Plus Series instruments meet the requirements outlined by UL for Hipot Testers. The Sentry Plus indicates the test potential (test voltage), has both visual and audible indication of failure and the STOP switch must be manually pressed prior to another measurement being made. The Sentry Plus Series instrument has a 100VA output $[(5000V * 20mA) = 100VA]$. The Sentry Plus Series instrument also measures and displays the output voltage directly at the output terminals during the test.

1.3 Controls and Indicators

1.3.1 Front Panel Controls and Indicators

Figure 1-2 illustrates the controls and indicators on the front panel of the Sentry Plus Series AC/DC/IR Hipot Tester. Table 1-1 identifies them with description and function.

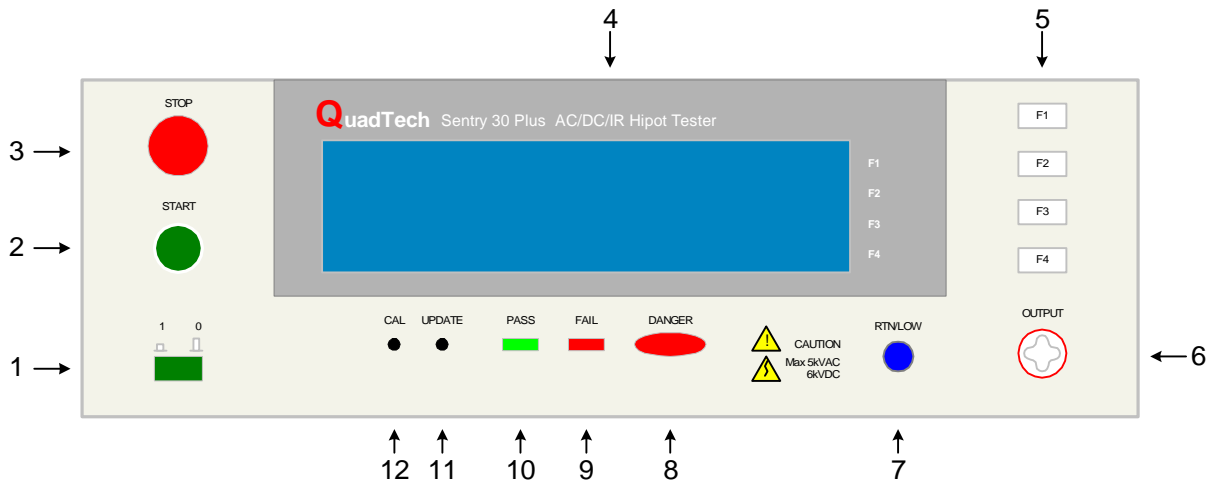

Figure 1-2: Sentry 30 Plus Front Panel Controls & Indicators

Table 1-1: Sentry 30 Plus Front Panel Controls & Indicators

Reference Number Fig 1-2	Name	Type	Function
1	Power	Green Push Button	Apply AC Power: 1=ON, 0=OFF
2	START	Green Push Button	Initiate Test: HV applied to OUTPUT terminal
3	STOP	Red Push Button	Stop Test: HV terminated at OUTPUT terminal
4	Display	LCD	Program Menu, Test Setup, Measurement Results, Memory Contents, Calibration
5	F1, F2, F3 and F4	Gray Push Buttons	Select Instrument Functions Keys perform different functions under different menus. Right side of display shows corresponding key function.
6	OUTPUT	White Custom Banana Socket	High Voltage (Potential) Terminal
7	RTN/LOW	Blue Banana Socket	RTN: Low voltage reference terminal LOW: Common ground reference terminal
8	DANGER	Red LED	When lit, high voltage is present at OUTPUT terminals
9	FAIL	Red LED	When lit, DUT judged as FAIL. Output voltage is immediately cut off. Press [STOP] to disable FAIL LED
10	PASS	Green LED	When lit, DUT judged as PASS
11	UPDATE	Recessed P-B	Qualified Service Personnel Only
12	CAL	Recessed P-B	Enable/Disable Instrument Calibration

1.3.2 Rear Panel Controls and Connectors

Figure 1-3 illustrates the controls and connectors on the rear panel of the Sentry Plus Series AC/DC/IR Hipot Tester. Table 1-2 identifies them with description and function.

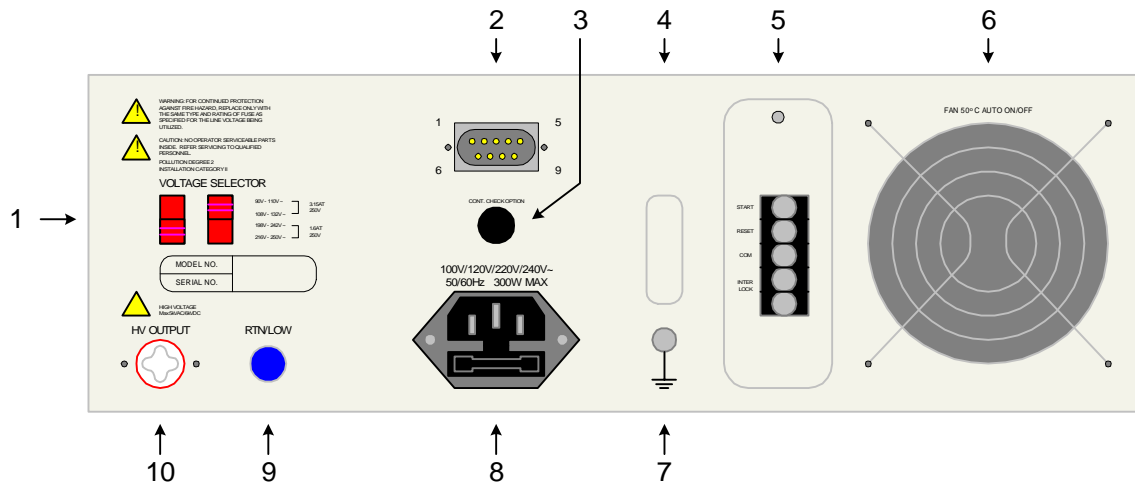

Figure 1-3: Rear Panel Sentry Plus Series Instrument

Table 1-2: Sentry Plus Series Rear Panel Controls & Connectors

Reference # Figure 1-3	Name	Type	Function
1	VOLTAGE SELECTOR	2 Red 2-position Slide Switches	Select Voltage Level corresponding to AC Source 90V – 110V: 3.15A 250V Slow Blow 110V – 130V: 3.15A 250V Slow Blow 200V – 240V: 1.6A 250V Slow Blow 220V – 250V: 1.6A 250V Slow Blow
2	Remote	Silver 9-pin D-Type Connector	Remote Connection: Inputs: Start, Reset Outputs: Pass, Fail, Under Test
3	CONT CHK OPT.	Black banana plug	Connection for Ground Continuity Check
4	TUV CE	Sticker	Instrument Safety Agency Listing
5	Remote	Black 5-screw Terminal Strip	Remote Connection: Start, Reset, Com, Interlock
6	Fan	SF11580AT 115V 50/60Hz 0.10A	Cool Unit: $T \geq 50^{\circ}\text{C} = \text{ON}$, $T < 45^{\circ}\text{C} = \text{OFF}$
7	Ground	Silver Banana Plug	Instrument Chassis Ground Connection
8	AC Line Input	Black 3-wire inlet module & fuse holder	Connection to AC power source Fuse Drawer: 3.15A 250V or 1.6A 250V (see #1)
9	RTN/LOW	Blue Banana Socket	RTN: Low voltage reference terminal LOW: Common ground reference terminal
10	HV OUTPUT	White Custom Banana Socket	Rear panel High Voltage (Potential) Terminal

1.4 Installation

1.4.1 Dimensions

The Sentry Plus series unit is supplied in a bench configuration, i.e., in a cabinet with resilient feet for placement on a table. Flip feet are provided under the front feet so that the Sentry Plus instrument can be tilted up for convenient operator viewing.

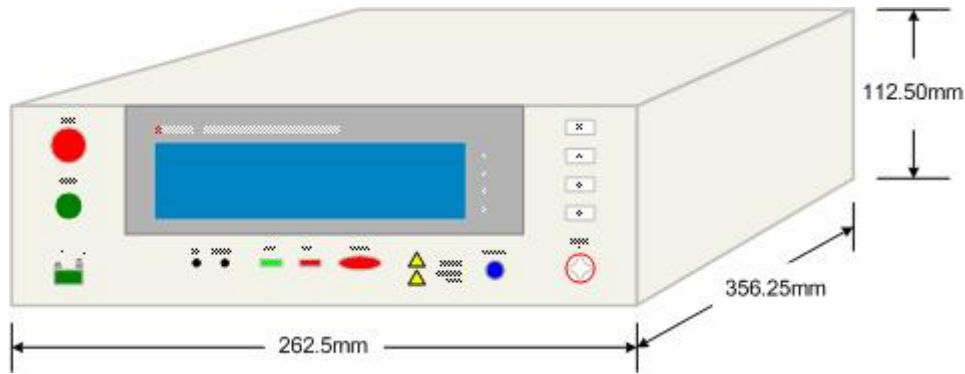

Figure 1-4: Sentry Plus Series Instrument Dimensions

1.4.2 Instrument Positioning

The Sentry Plus unit contains a graphic display for direct readout of measured parameters. The optimum angle for viewing is slightly down and about 10 degrees either side of center. For bench operation the front flip feet should always be used to angle the instrument up. In bench or rack mount applications the instrument should be positioned with consideration for ample air flow around the rear panel fan ventilation hole. An open space of at least 75mm is recommended behind the rear panel. Testing should be performed on a non-conductive surface. An ESD mat is not a recommended test platform.

1.4.3 Power Requirements

The Sentry Plus instrument can be operated from a power source of 90 to 132V AC or 198 to 250V AC. Power connection is via the rear panel through a standard receptacle. Before connecting the 3-wire power cord between the unit and AC power source, make sure the voltage selection switches on the rear panel (Figure 1-5) are in accordance with the power source being used. For a 90-132V source, use a 3.15A 250V fuse. For a 198-250V source, use a 1.6A 250V fuse. Always use an outlet that has a properly connected protection ground.

WARNING

MAKE SURE THE UNIT HAS BEEN DISCONNECTED FROM ITS AC POWER SOURCE FOR AT LEAST FIVE MINUTES BEFORE PROCEEDING.

Procedure For Changing A Sentry Plus Series Fuse

Remove the fuse drawer, by pressing the black tab located at the center of the extended fuse drawer, just below the 3-prong receptacle, and pull outward.

Once the fuse drawer has been removed from the instrument slide out the fuse from the holder and replace. Make sure the new fuse is of the proper rating. Note that the fuse drawer can also be used to store a spare fuse.

Install the fuse drawer back in the inlet module by pushing in until it locks securely in place.

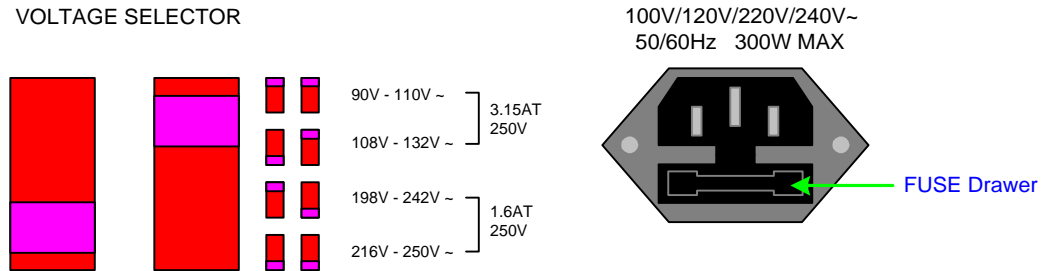

Figure 1-5: Close-Up of Sentry Plus Series Rear Panel

1.4.4 Safety Inspection

Before operating the instrument inspect the power inlet module on the rear of the Sentry Plus to ensure that the properly rated fuse is in place, otherwise damage to the unit is possible. Make sure that the voltage selector switches are set in accordance with the power source in use. Refer to paragraph 1.4.3 and Figure 1-5.

The Sentry Plus instrument is shipped with a standard U.S. power cord, QuadTech P/N 4200-0300 (with Belden SPH-386 socket or equivalent, and a 3-wire plug conforming to IEC 320). Make sure the instrument is only used with these cables (or other approved international cord set) to ensure that the instrument is provided with connection to protective earth ground.

The surrounding environment should be free from excessive dust to prevent contamination of electronic circuits. The surrounding environment should also be free from excessive vibration. Do not expose the Sentry Plus instrument to direct sunlight, extreme temperature or humidity variations, or corrosive chemicals.

Section 2: Operation

2.1 Terms and Conventions

Table 2-1: Measurement Unit Prefixes

<u>Multiple</u>	<u>Scientific</u>	<u>Engineering</u>	<u>Symbol</u>
1000000000000000	10 ¹⁵	Peta	P
1000000000000	10 ¹²	Tera	T
1000000000	10 ⁹	Giga	G
1000000	10 ⁶	Mega	M
1000	10 ³	Kilo	k
.001	10 ⁻³	milli	m
.000001	10 ⁻⁶	micro	u
.000000001	10 ⁻⁹	nano	n
.000000000001	10 ⁻¹²	pico	p
.000000000000001	10 ⁻¹⁵	femto	f

ARcing: Sparking or ‘flashing over’ caused by a breakdown of electrical insulation.

Current:

AC: Alternating Current. AC is an electrical current that has one polarity during part of the cycle and the opposing polarity during the other part of the cycle. Residential electricity is AC.

DC: Direct Current. Non-reversing polarity. The movement of charge is in one direction. Used to describe both current and voltage. Batteries supply direct current (DC).

Charging Current: An insulated product exhibits the basic characteristics of a capacitor. Application of a voltage across the insulation causes a current to flow as the capacitor charges. This current instantaneously rises to a high value as voltage is applied then exponentially decays to zero as the DUT becomes fully charged. Charging current decays to zero much faster than dielectric absorption.

Dielectric Absorption:	The physical phenomenon in which insulation appears to absorb and retain an electrical charge slowly over time. Apply a voltage to a capacitor for an extended period of time. Then quickly discharge it to zero voltage. Leave the capacitor open circuited for a period of time then connect a voltmeter to it and measure the residual voltage. The residual voltage is caused by the dielectric absorption of the capacitor.
Dielectric Strength:	The ratio between the voltage at which breakdown of the insulating material occurs and the distance between the two points subject to the applied voltage.
Dielectric Withstand Test:	This is the most common electrical safety test performed. A high voltage (either AC or DC) is applied to determine if a breakdown will occur in the insulation of the DUT. Dielectric Withstand is also referred to as a hipot (high potential) test.
Discharge:	The act of draining off an electrical charge to ground. Devices that retain charge should be discharged after an IR test or DC hipot test.
DUT:	Device Under Test. (i.e. the product being tested).
Frequency:	The rate at which current or voltage reverses polarity and then back again completing a full cycle, measured in Hertz (Hz) or cycles/second. AC Line Frequency = 50/60 Hz.
Ground:	
Ground:	The base reference from which voltages are measured, nominally the same potential as the earth. Ground is also the side of a circuit that is at the same potential as the base reference.
Ground Bond Test:	Test to verify that all conductive parts of a product that are exposed to user contact are connected to the power line ground. The ground bond test verifies the integrity of the ground connection using a high current AC signal with current level as high as 30Amps. Ground bond provides a better simulation of how a product will perform under an actual fault condition.
Ground Continuity:	Test to verify that all conductive parts of a product that are exposed to user contact are connected to the power line ground. GC Test normally performed with a low current DC signal that checks to ensure the ground connection has a resistance of $<1\Omega$.

Insulation Resistance: Measures the total resistance between any two points separated by electrical insulation. The IR test determines how effective the dielectric (insulation) is in resisting the flow of electrical current.

Interface:

IEEE-488: General Purpose Interface Bus (GPIB). GPIB is an industry standard definition of a Parallel bus connection for the purpose of communicating data between devices.

RS232: An industry standard definition for a Serial line communication link or port.

Scanner: An electronic device designed to switch or matrix signals.

Leakage Current (LC):

Leakage Current: The residual flow of current that flows through the insulation after a high voltage has been applied for a period of time. The leakage current is equal to the applied voltage divided by the insulation resistance. Leakage current is the main measured value for AC hipot and DC hipot.

Applied Part LC Test: A line leakage current test that measures the current that would flow from, to or between applied parts such as sensor and patient leads. This test is the most complicated and time-consuming line leakage test.

Earth LC Test: The most important and most common of the line leakage tests. Earth leakage current is basically the current flowing back through the ground conductor on the power cord. It is measured by opening the ground conductor, inserting a circuit with the simulated impedance of the human body then measuring the voltage across part of the circuit with a true RMS voltmeter.

Enclosure LC Test: A line leakage test that measures the current that flows through the human body if the body had touched the enclosure of the DUT.

Line LC Test: A line voltage leakage current test simulates the effect of a person touching exposed metal parts of a product and detects whether or not the leakage current that flows through the person's body remains below a safe level. Apply power to the product being tested, then measure the leakage current from any exposed metal on the chassis of the product under a fault conditions such as "no ground". A special circuit is used to simulate the impedance of the human body.

Limits:

High Limit: The upper value for a test to be considered a pass. If the measured value is higher than the high limit the test is considered a fail. In hipot, leakage current and ground bond test modes a high limit is required.

Low Limit: The lower value for a test to be considered a pass. If the measured value is lower than the low limit the test is considered a fail. In insulation resistance test mode a low limit is required. In an AC or DC Hipot test, the low limit FAIL decision occurs at the end of the programmed test time.

Mode: The test to be performed such as: AC Hipot (AC), DC Hipot (DC), Insulation Resistance (IR), Ground Continuity (GC) or Pause (PA).

Step: The order in which the tests will be performed. For example if step 1 is a ground continuity test, step 2 an AC hipot and step 3 an insulation resistance measurement then when the START button is pressed, the Sentry will perform a GC test followed by an AC test then an IR test.

Test Time:

Ramp: The time for the voltage to climb to the programmed level.

Dwell: The time for the voltage to settle at the programmed level.

Test: The time that the voltage is held at the programmed level and a comparison is made to the limits.

Fall: The time for the voltage to decrease back to 0.

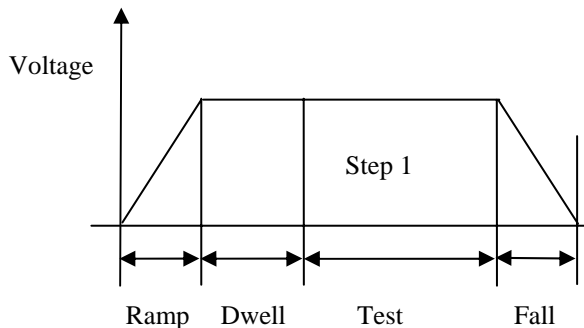

Test Current:

Real Current:

The resistive current component of the device under test. The resistive component is attributed to the resistance of the device's insulation.

Total Current:

A measure of the resistive and reactive current components of the device under test. The reactive component is attributed to the capacitive or inductive components of the circuit

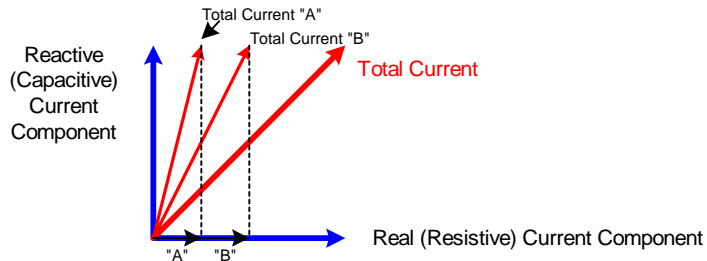

$$\frac{\text{Real "B"}}{\text{Real "A"}} = \frac{200}{100} > 100\% \text{ Change}$$

$$\frac{\text{Total "B"}}{\text{Total "A"}} = \frac{101}{100} > 1\% \text{ Change}$$

$$\frac{\text{Reactive "B"}}{\text{Reactive "A"}} = \frac{100}{100} > 0\% \text{ Change}$$

2.2 Startup

Check to make sure the Red Voltage Selector Switches on the rear panel agree with the power source available. Depending on the power source the switch positions should be in the up or down positions as shown in Figure 1-5 (Close-Up of Sentry Plus Series Rear Panel).

WARNING

NEVER TOUCH THE TEST LEADS IN ANY MANNER (this includes insulation on all wires and clips) when HIGH VOLTAGE IS APPLIED and red **DANGER** LED is ON.

USE ALL PRECAUTIONS NECESSARY TO AVOID TOUCHING THE DEVICE UNDER TEST WHEN THE RED **DANGER** LED IS ON OR FLASHING.

Connect the instrument power cord to the source of proper voltage. **The instrument is to be used only with three-wire grounded outlets.**

Power is applied to the Sentry Plus Series instrument by pressing the green [POWER] switch on the front panel to the ON (1 position). The Sentry Plus Series unit should warm up for a period of at least 15 minutes prior to use.

WARNING

DO NOT TURN INSTRUMENT POWER ON OR OFF WITH TEST DEVICES CONNECTED.

2.3 Programming Electrical Safety Tests

The Sentry Plus Series instrument is capable of performing the tests listed in Table 2-2. A single-step test can be performed on a device and is programmed as described in paragraphs 2.4 – 2.9. When the device under test requires a multi-step test the order of test precedence is important. Refer to paragraph 2.10 for test setup store/recall instructions and to paragraph 2.11 for instructions on programming a multi-step test.

Table 2-2: Sentry Plus Series Electrical Safety Tests

Test	Software Designation	Programming Instructions Paragraph	Sentry Plus Series Instrument
Ground Continuity	GC	2.4	10, 20, 30
Open/Short Circuit	OS	2.5	10, 20, 30
AC Hipot	AC	2.6	10, 20, 30
DC Hipot	DC	2.7	20, 30
Pause	PA	2.8	10, 20, 30
Insulation Resistance	IR	2.9	30
Storing a Test Setup		2.10	10, 20, 30
Multi-Step		2.11	10, 20, 30

NOTE:

This manual is set up so if you follow the instructions in paragraphs 2.4 through 2.10 and you will have programmed a 6-step test setup and stored it to memory location 1.

Function keys of the STAND BY Display

The function keys on the right hand side of the display allow the operator to access the numerous menus imbedded within the Sentry Plus Series instrument software. Familiarize yourself with these menus prior to programming a test. Figure 2-1 illustrates the STAND BY display and lists the functions that can be accessed by pressing the [F1] through [F4] keys.

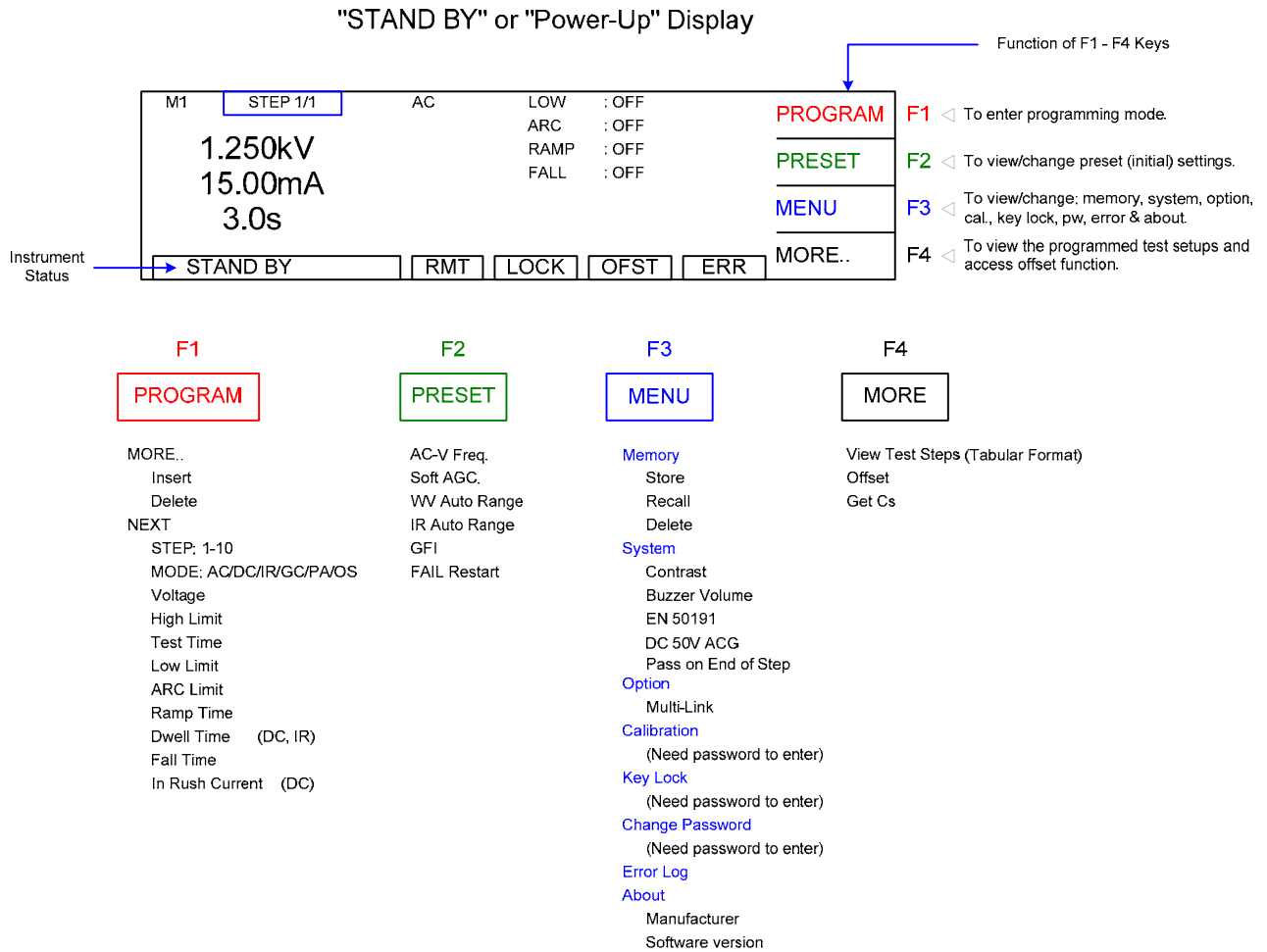

Figure 2-1: STAND BY Function Key Menus

POWER UP and STAND BY Displays

The Sentry Plus Series instruments have multiple menus or displays that may seem confusing at first glance. In an attempt to clarify the numerous functions of the software, this instruction manual will illustrate these displays in a (hopefully) logical format. The function keys (F1, F2, F3 & F4) perform different tasks depending upon the menu currently shown on the display. Figure 2-2 illustrates the instrument display when the instrument is initially turned on.

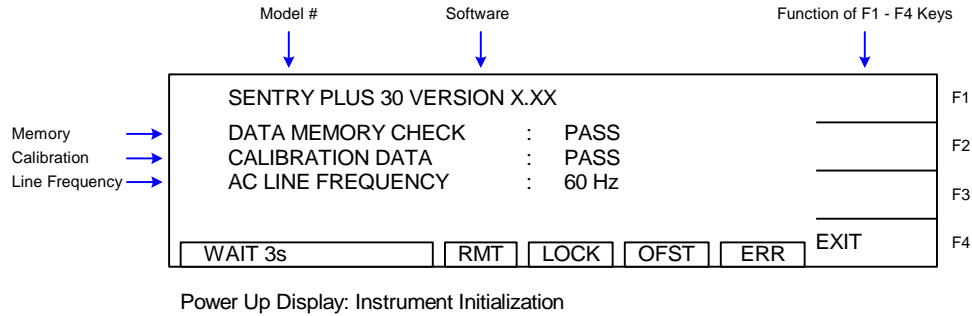

Figure 2-2: Power-Up Display

After 3 seconds, the instrument display reverts to the STAND BY display as illustrated in Figure 2-3. The box in the lower left hand corner denotes the instrument status.

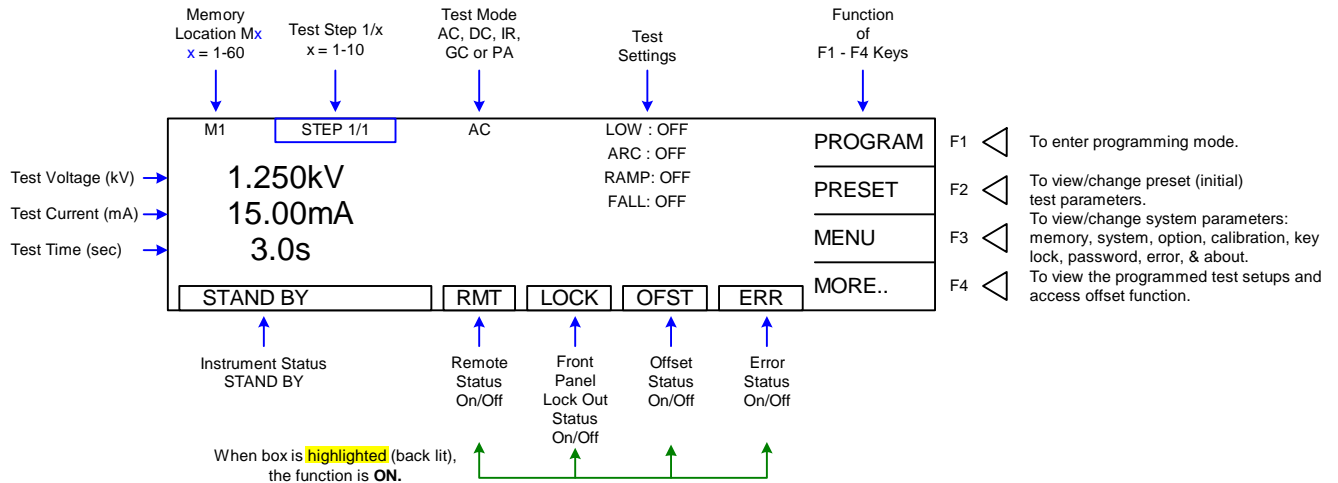

Figure 2-3: STAND BY Display

To access the programming function of the Sentry Plus Series instrument in the STAND BY menu, press the [F1] key (PROGRAM). Once in the PROGRAM display, select the test step then the test mode (AC, DC, IR, GC, PA or OSC). Paragraphs 2.4 - 2.9 illustrate how to program the specific parameters of each of the 6 tests.

NOTE

This manual is set up so if you follow the instructions in paragraphs 2.4-2.10 you will have programmed a 6-step test (GC, AC, DC, IR and PA) and saved to memory location 1.

PROGRAM Mode Displays

Figure 2-4 illustrates each program mode display for quick reference. The box in the lower left hand corner denotes the instrument status. For clarity, a green arrow (◀) is used to denote which function key (F1 – F4) is pressed to get to the next display screen.

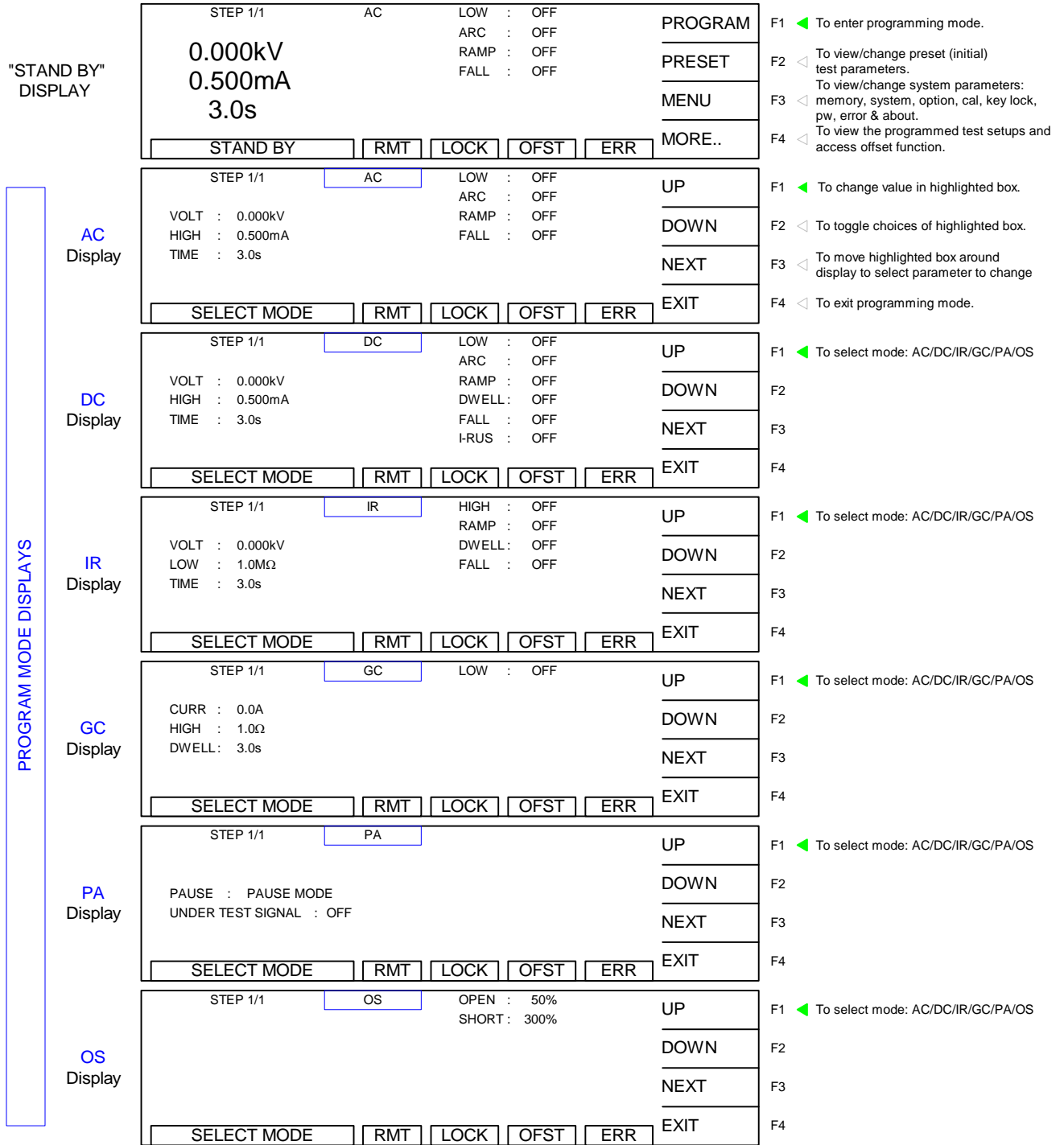
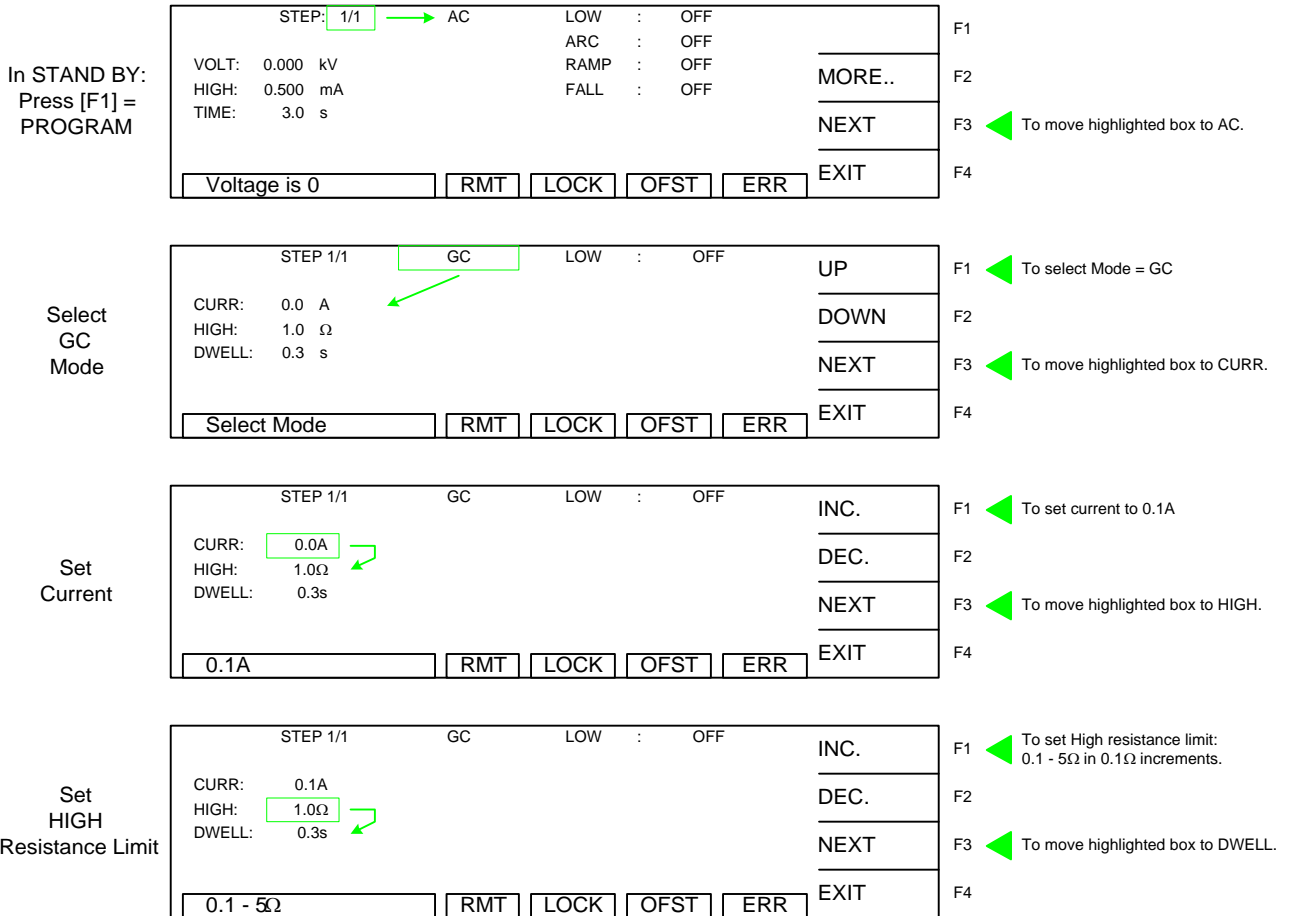

Figure 2-4: STAND BY & PROGRAM Mode Displays

2.4 Programming a Ground Continuity Test

This test is applicable to the Sentry 10, 20 and 30 Plus instruments. A Ground Continuity (GC) test is usually done first to verify the ground connection before high voltage is applied in the AC & DC Hipot tests. With the instrument in 'stand-by' status, press [F1] = PROGRAM. The AC test mode programming screen is displayed. Follow the **green** arrows (□) on the right side of this diagram to program the individual GC test parameters.



Continue on next page.

Programming a GC Test (continued):

Set DWEELL Time	<table border="0" style="width: 100%; border-collapse: collapse;"> <tr> <td style="text-align: center;">STEP 1/1</td> <td style="text-align: center;">GC</td> <td style="text-align: center;">LOW</td> <td style="text-align: center;">:</td> <td style="text-align: center;">OFF</td> <td style="text-align: center;">INC.</td> </tr> <tr> <td>CURR:</td> <td>0.1A</td> <td></td> <td></td> <td></td> <td>DEC.</td> </tr> <tr> <td>HIGH:</td> <td>1.2Ω</td> <td></td> <td></td> <td></td> <td>NEXT</td> </tr> <tr> <td>DWEELL:</td> <td style="border: 1px solid green; padding: 2px;">0.3s</td> <td></td> <td></td> <td></td> <td>EXIT</td> </tr> <tr> <td colspan="6" style="border-top: 1px solid black; padding-top: 5px;"> <table border="0" style="width: 100%; border-collapse: collapse;"> <tr> <td style="border: 1px solid black; padding: 2px;">0.1 - 1s</td> <td style="border: 1px solid black; padding: 2px;">RMT</td> <td style="border: 1px solid black; padding: 2px;">LOCK</td> <td style="border: 1px solid black; padding: 2px;">OFST</td> <td style="border: 1px solid black; padding: 2px;">ERR</td> <td style="border: 1px solid black; padding: 2px;">EXIT</td> </tr> </table> </td> </tr> </table>	STEP 1/1	GC	LOW	:	OFF	INC.	CURR:	0.1A				DEC.	HIGH:	1.2Ω				NEXT	DWEELL:	0.3s				EXIT	<table border="0" style="width: 100%; border-collapse: collapse;"> <tr> <td style="border: 1px solid black; padding: 2px;">0.1 - 1s</td> <td style="border: 1px solid black; padding: 2px;">RMT</td> <td style="border: 1px solid black; padding: 2px;">LOCK</td> <td style="border: 1px solid black; padding: 2px;">OFST</td> <td style="border: 1px solid black; padding: 2px;">ERR</td> <td style="border: 1px solid black; padding: 2px;">EXIT</td> </tr> </table>						0.1 - 1s	RMT	LOCK	OFST	ERR	EXIT	<p>F1 To set Dwell time: 0.1 - 1s in 0.1s increments</p> <p>F2</p> <p>F3 To move highlighted box to LOW.</p> <p>F4</p>
STEP 1/1	GC	LOW	:	OFF	INC.																																	
CURR:	0.1A				DEC.																																	
HIGH:	1.2Ω				NEXT																																	
DWEELL:	0.3s				EXIT																																	
<table border="0" style="width: 100%; border-collapse: collapse;"> <tr> <td style="border: 1px solid black; padding: 2px;">0.1 - 1s</td> <td style="border: 1px solid black; padding: 2px;">RMT</td> <td style="border: 1px solid black; padding: 2px;">LOCK</td> <td style="border: 1px solid black; padding: 2px;">OFST</td> <td style="border: 1px solid black; padding: 2px;">ERR</td> <td style="border: 1px solid black; padding: 2px;">EXIT</td> </tr> </table>						0.1 - 1s	RMT	LOCK	OFST	ERR	EXIT																											
0.1 - 1s	RMT	LOCK	OFST	ERR	EXIT																																	
Set LOW Resistance Limit	<table border="0" style="width: 100%; border-collapse: collapse;"> <tr> <td style="text-align: center;">STEP 1/1</td> <td style="text-align: center;">GC</td> <td style="text-align: center;">LOW</td> <td style="text-align: center;">:</td> <td style="text-align: center;">OFF</td> <td style="text-align: center;">INC.</td> </tr> <tr> <td>CURR:</td> <td>0.1A</td> <td></td> <td></td> <td></td> <td>DEC.</td> </tr> <tr> <td>HIGH:</td> <td>1.2Ω</td> <td></td> <td></td> <td></td> <td>NEXT</td> </tr> <tr> <td>DWEELL:</td> <td>0.5s</td> <td></td> <td></td> <td></td> <td>EXIT</td> </tr> <tr> <td colspan="6" style="border-top: 1px solid black; padding-top: 5px;"> <table border="0" style="width: 100%; border-collapse: collapse;"> <tr> <td style="border: 1px solid black; padding: 2px;">0 - 5Ω</td> <td style="border: 1px solid black; padding: 2px;">RMT</td> <td style="border: 1px solid black; padding: 2px;">LOCK</td> <td style="border: 1px solid black; padding: 2px;">OFST</td> <td style="border: 1px solid black; padding: 2px;">ERR</td> <td style="border: 1px solid black; padding: 2px;">EXIT</td> </tr> </table> </td> </tr> </table>	STEP 1/1	GC	LOW	:	OFF	INC.	CURR:	0.1A				DEC.	HIGH:	1.2Ω				NEXT	DWEELL:	0.5s				EXIT	<table border="0" style="width: 100%; border-collapse: collapse;"> <tr> <td style="border: 1px solid black; padding: 2px;">0 - 5Ω</td> <td style="border: 1px solid black; padding: 2px;">RMT</td> <td style="border: 1px solid black; padding: 2px;">LOCK</td> <td style="border: 1px solid black; padding: 2px;">OFST</td> <td style="border: 1px solid black; padding: 2px;">ERR</td> <td style="border: 1px solid black; padding: 2px;">EXIT</td> </tr> </table>						0 - 5Ω	RMT	LOCK	OFST	ERR	EXIT	<p>F1 To set Low resistance limit: 0 - 5Ω in 0.1Ω increments.</p> <p>F2</p> <p>F3 To move highlighted box to STEP.</p> <p>F4</p>
STEP 1/1	GC	LOW	:	OFF	INC.																																	
CURR:	0.1A				DEC.																																	
HIGH:	1.2Ω				NEXT																																	
DWEELL:	0.5s				EXIT																																	
<table border="0" style="width: 100%; border-collapse: collapse;"> <tr> <td style="border: 1px solid black; padding: 2px;">0 - 5Ω</td> <td style="border: 1px solid black; padding: 2px;">RMT</td> <td style="border: 1px solid black; padding: 2px;">LOCK</td> <td style="border: 1px solid black; padding: 2px;">OFST</td> <td style="border: 1px solid black; padding: 2px;">ERR</td> <td style="border: 1px solid black; padding: 2px;">EXIT</td> </tr> </table>						0 - 5Ω	RMT	LOCK	OFST	ERR	EXIT																											
0 - 5Ω	RMT	LOCK	OFST	ERR	EXIT																																	
<p>[F1] : Program Step 2 or [F4] : Exit Program Mode</p>	<table border="0" style="width: 100%; border-collapse: collapse;"> <tr> <td style="text-align: center;">STEP: 1/1</td> <td style="text-align: center;">GC</td> <td style="text-align: center;">LOW</td> <td style="text-align: center;">:</td> <td style="text-align: center;">0.3Ω</td> <td style="text-align: center;">NEW</td> </tr> <tr> <td>CURR:</td> <td>0.1A</td> <td></td> <td></td> <td></td> <td>MORE..</td> </tr> <tr> <td>HIGH:</td> <td>1.2Ω</td> <td></td> <td></td> <td></td> <td>NEXT</td> </tr> <tr> <td>DWEELL:</td> <td>0.5s</td> <td></td> <td></td> <td></td> <td>EXIT</td> </tr> <tr> <td colspan="6" style="border-top: 1px solid black; padding-top: 5px;"> <table border="0" style="width: 100%; border-collapse: collapse;"> <tr> <td style="border: 1px solid black; padding: 2px;">1 - 10</td> <td style="border: 1px solid black; padding: 2px;">RMT</td> <td style="border: 1px solid black; padding: 2px;">LOCK</td> <td style="border: 1px solid black; padding: 2px;">OFST</td> <td style="border: 1px solid black; padding: 2px;">ERR</td> <td style="border: 1px solid black; padding: 2px;">EXIT</td> </tr> </table> </td> </tr> </table>	STEP: 1/1	GC	LOW	:	0.3Ω	NEW	CURR:	0.1A				MORE..	HIGH:	1.2Ω				NEXT	DWEELL:	0.5s				EXIT	<table border="0" style="width: 100%; border-collapse: collapse;"> <tr> <td style="border: 1px solid black; padding: 2px;">1 - 10</td> <td style="border: 1px solid black; padding: 2px;">RMT</td> <td style="border: 1px solid black; padding: 2px;">LOCK</td> <td style="border: 1px solid black; padding: 2px;">OFST</td> <td style="border: 1px solid black; padding: 2px;">ERR</td> <td style="border: 1px solid black; padding: 2px;">EXIT</td> </tr> </table>						1 - 10	RMT	LOCK	OFST	ERR	EXIT	<p>F1 To go to Step 2.</p> <p>F2</p> <p>F3</p> <p>F4 To exit programming mode and return to STAND BY status.</p>
STEP: 1/1	GC	LOW	:	0.3Ω	NEW																																	
CURR:	0.1A				MORE..																																	
HIGH:	1.2Ω				NEXT																																	
DWEELL:	0.5s				EXIT																																	
<table border="0" style="width: 100%; border-collapse: collapse;"> <tr> <td style="border: 1px solid black; padding: 2px;">1 - 10</td> <td style="border: 1px solid black; padding: 2px;">RMT</td> <td style="border: 1px solid black; padding: 2px;">LOCK</td> <td style="border: 1px solid black; padding: 2px;">OFST</td> <td style="border: 1px solid black; padding: 2px;">ERR</td> <td style="border: 1px solid black; padding: 2px;">EXIT</td> </tr> </table>						1 - 10	RMT	LOCK	OFST	ERR	EXIT																											
1 - 10	RMT	LOCK	OFST	ERR	EXIT																																	

END GC Test Programming. After selecting the LOW resistance limit, one can either press [F1] = NEW to change the step number in the highlighted box (1-10) and start programming STEP 2-10 **OR** one can press [F4] = EXIT to exit programming function and return to STAND BY status.

For this example, press [F1] = NEW and proceed to program step 2 as an OS Check (¶ 2.5).

2.5 Programming an Open/Short Circuit (OS) Check

The Open/Short Circuit Detection Mode will ensure the Device Under Test is connected properly and is does not have a short circuit. In Program mode OS can be selected as one of the steps within the test. There are two programmable parameters Open % and Short %. Open % is equivalent to a low limit. Short % would be considered a high limit. Once programming is finalized, an offset should be performed and the Get Cs function must be ran to learn the Capacitance of the device under test. This learned Capacitance value will then be compared to the Open % and Short % for Pass/Fail judgment. This function is typically programmed prior to a hipot test to check the connection to the device under test before applying high voltage.

Open Check: In hipot testing, a low leakage current may generate a PASS. If the connection is faulty between the hipot and the DUT, the test could pass even if the DUT was not tested. Open Check is similar to using a low limit in an AC hipot test to ensure the connection of the DUT. In some cases, such as DC Hipot, a low limit is not feasible. Open Check will ensure that the DUT is connected.

The Open Check sets the judgment test result (Pass/Fail) to open circuit condition and compares the test reading with the standard capacitance value (Cs). If the test reading is within the programmed % then the judgment is Pass. The Open Check can be programmed from 10% - 100% and the default 50%.

Short Check: In some cases, the DUT is shorted prior to testing. If the product is shorted, there is no need to perform hipot.

The Short Check sets the judgment test result (Pass/Fail) to short circuit condition and compares the test reading to the standard capacitance value (Cs). If the test reading is within the programmed % then the judgment is Pass. The Short Check can be set to Off or programmed from 100% - 500%. The default value is 300%.

When using OS mode, program the test, attach the DUT, press [F4] = MORE and then [F2] = GET Cs to obtain the DUT's standard capacitance value. The Cs value is saved with the test program in instrument memory. The Cs value is applicable to that product only.

To illustrate this function: for a particular DUT, the Sentry Plus instrument learned Cs = 0.241nF and the Open Check is set to 50%. If the measured Cs is within 50% of the learned Cs, then the OSC result is a PASS. If the measured Cs is greater than 0.121nF (50% of .241nF), then the OSC result is a PASS. If the measured Cs is less than 0.121nF, then the OSC result is an OPEN.

If the Short Check is set to 300%. If the measured Cs is less than 300% of the learned Cs, then the OSC result is a PASS. If the measured Cs is greater than 300% of the learned Cs, then the OSC result is a FAIL. If the measured Cs is greater than 0.723nF (300% of .241nF), then the OSC result is a SHORT.

Programming an OS Check:

This test is applicable to the Sentry 10, 20 and 30 Plus instruments. With the instrument in 'stand-by' status, press [F1] = PROGRAM. If continuing the 6-step example from ¶2.4, you are already in program mode and on the AC test mode page. Follow the green arrows (→) on the right side of this diagram to program the individual OS parameters.

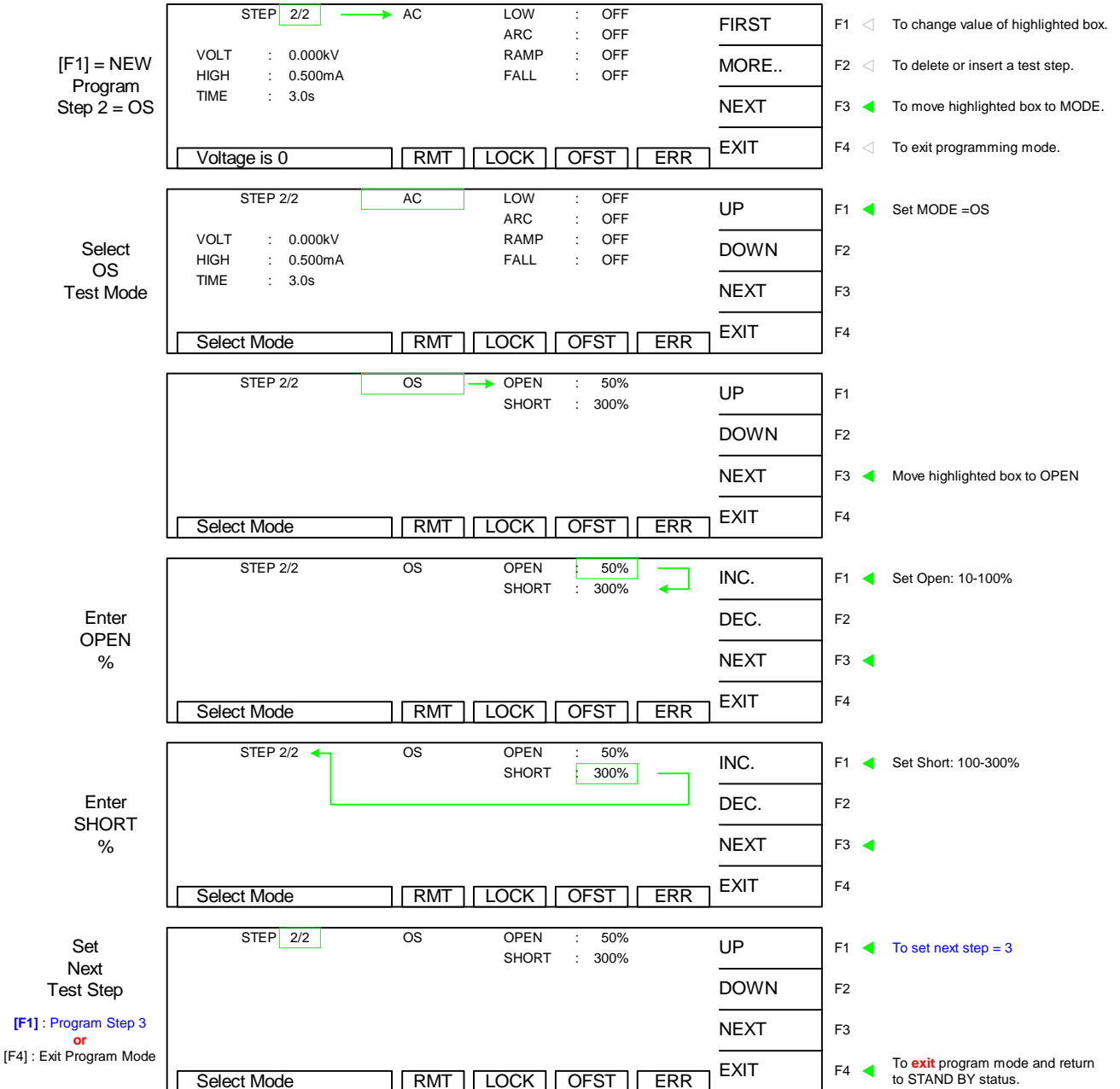

END OSC Programming. After selecting the SHORT %, one can either press [F1] = NEW to change the step number in the highlighted box (1-10) and start programming STEP 3-10, **OR** one can press [F4] = EXIT to exit programming function and return to STAND BY status.

For this example, press [F1] = NEW and proceed to program step 3 as an AC Hipot Test (¶ 2.6).

2.6 Programming an AC Hipot Test

This test is applicable to the Sentry 10, 20 and 30 Plus instruments. With the instrument in 'stand-by' status, press [F1] = PROGRAM. If continuing the 6-step example from ¶2.5, you are already in program mode and on the AC test mode page. Follow the green arrows (□) on the right side of this diagram to program the individual AC hipot test parameters.

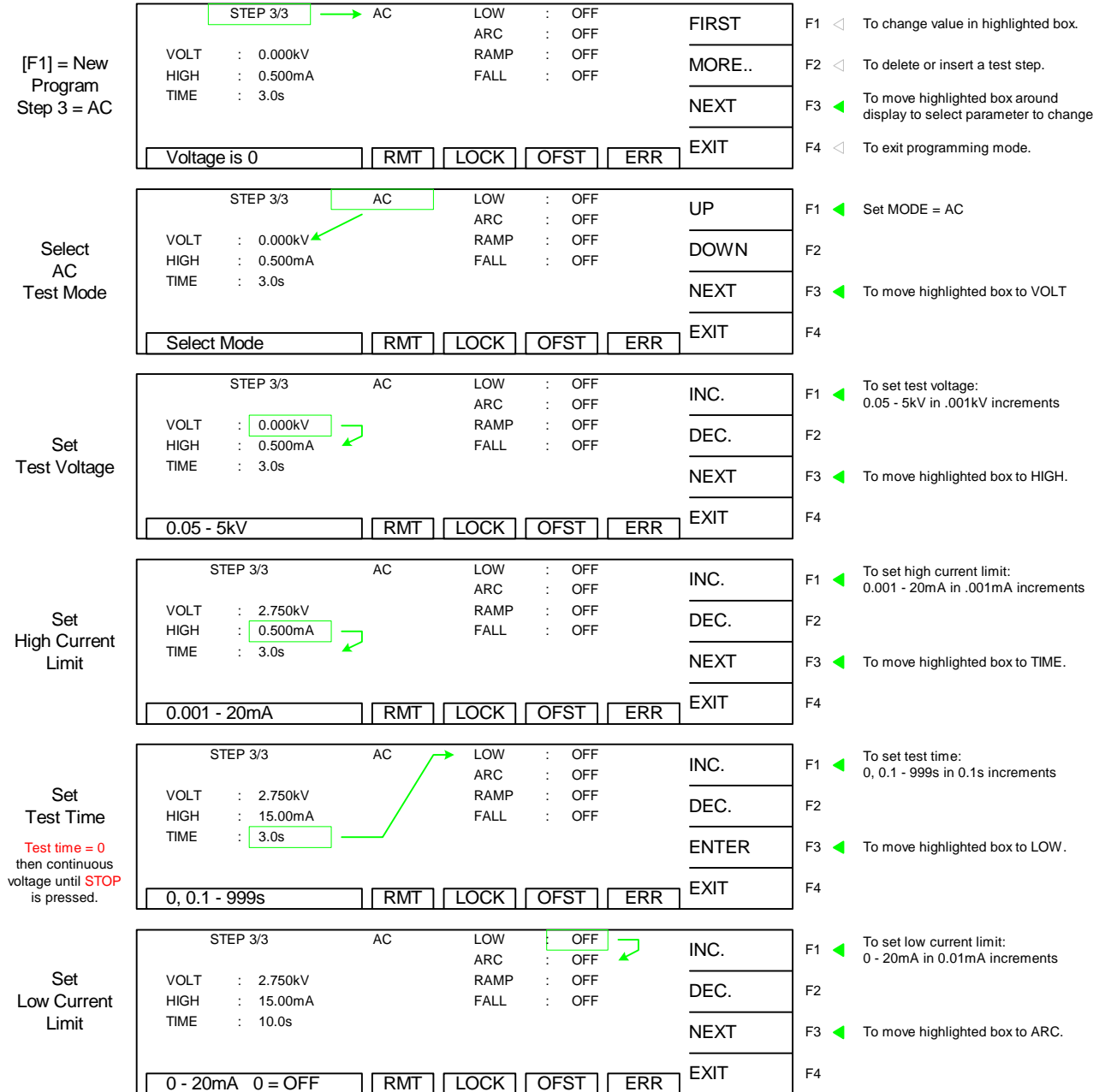

Continue on next page.

Programming an AC Hipot Test (continued)

Set Arc Limit	<table border="1" style="width: 100%; border-collapse: collapse;"> <tr> <td style="text-align: center;">STEP 3/3</td> <td style="text-align: center;">AC</td> <td>LOW</td> <td>: 3.00mA</td> <td style="text-align: center;">INC.</td> </tr> <tr> <td>VOLT</td> <td>: 2.750kV</td> <td>ARC</td> <td>: OFF</td> <td style="text-align: center;">DEC.</td> </tr> <tr> <td>HIGH</td> <td>: 15.00mA</td> <td>RAMP</td> <td>: OFF</td> <td style="text-align: center;">NEXT</td> </tr> <tr> <td>TIME</td> <td>: 10.0s</td> <td>FALL</td> <td>: OFF</td> <td style="text-align: center;">EXIT</td> </tr> <tr> <td colspan="5" style="text-align: center;"> <table border="1" style="width: 100%; border-collapse: collapse;"> <tr> <td style="width: 25%;">1 - 20mA 0 = OFF</td> <td style="width: 10%;">RMT</td> <td style="width: 10%;">LOCK</td> <td style="width: 10%;">OFST</td> <td style="width: 10%;">ERR</td> <td style="width: 10%;">EXIT</td> </tr> </table> </td> </tr> </table>	STEP 3/3	AC	LOW	: 3.00mA	INC.	VOLT	: 2.750kV	ARC	: OFF	DEC.	HIGH	: 15.00mA	RAMP	: OFF	NEXT	TIME	: 10.0s	FALL	: OFF	EXIT	<table border="1" style="width: 100%; border-collapse: collapse;"> <tr> <td style="width: 25%;">1 - 20mA 0 = OFF</td> <td style="width: 10%;">RMT</td> <td style="width: 10%;">LOCK</td> <td style="width: 10%;">OFST</td> <td style="width: 10%;">ERR</td> <td style="width: 10%;">EXIT</td> </tr> </table>					1 - 20mA 0 = OFF	RMT	LOCK	OFST	ERR	EXIT	<p>F1 ◀ Set arc current limit: 1-20mA in 0.1mA increments</p> <p>F2</p> <p>F3 ◀ To move highlighted box to RAMP.</p> <p>F4</p>	
STEP 3/3	AC	LOW	: 3.00mA	INC.																														
VOLT	: 2.750kV	ARC	: OFF	DEC.																														
HIGH	: 15.00mA	RAMP	: OFF	NEXT																														
TIME	: 10.0s	FALL	: OFF	EXIT																														
<table border="1" style="width: 100%; border-collapse: collapse;"> <tr> <td style="width: 25%;">1 - 20mA 0 = OFF</td> <td style="width: 10%;">RMT</td> <td style="width: 10%;">LOCK</td> <td style="width: 10%;">OFST</td> <td style="width: 10%;">ERR</td> <td style="width: 10%;">EXIT</td> </tr> </table>					1 - 20mA 0 = OFF	RMT	LOCK	OFST	ERR	EXIT																								
1 - 20mA 0 = OFF	RMT	LOCK	OFST	ERR	EXIT																													
Set Ramp Time	<table border="1" style="width: 100%; border-collapse: collapse;"> <tr> <td style="text-align: center;">STEP 3/3</td> <td style="text-align: center;">AC</td> <td>LOW</td> <td>: 3.00mA</td> <td style="text-align: center;">INC.</td> </tr> <tr> <td>VOLT</td> <td>: 2.750kV</td> <td>ARC</td> <td>: OFF</td> <td style="text-align: center;">DEC.</td> </tr> <tr> <td>HIGH</td> <td>: 15.00mA</td> <td>RAMP</td> <td>: OFF</td> <td style="text-align: center;">NEXT</td> </tr> <tr> <td>TIME</td> <td>: 10.0s</td> <td>FALL</td> <td>: OFF</td> <td style="text-align: center;">EXIT</td> </tr> <tr> <td colspan="5" style="text-align: center;"> <table border="1" style="width: 100%; border-collapse: collapse;"> <tr> <td style="width: 25%;">0 - 999s 0 = OFF</td> <td style="width: 10%;">RMT</td> <td style="width: 10%;">LOCK</td> <td style="width: 10%;">OFST</td> <td style="width: 10%;">ERR</td> <td style="width: 10%;">EXIT</td> </tr> </table> </td> </tr> </table>	STEP 3/3	AC	LOW	: 3.00mA	INC.	VOLT	: 2.750kV	ARC	: OFF	DEC.	HIGH	: 15.00mA	RAMP	: OFF	NEXT	TIME	: 10.0s	FALL	: OFF	EXIT	<table border="1" style="width: 100%; border-collapse: collapse;"> <tr> <td style="width: 25%;">0 - 999s 0 = OFF</td> <td style="width: 10%;">RMT</td> <td style="width: 10%;">LOCK</td> <td style="width: 10%;">OFST</td> <td style="width: 10%;">ERR</td> <td style="width: 10%;">EXIT</td> </tr> </table>					0 - 999s 0 = OFF	RMT	LOCK	OFST	ERR	EXIT	<p>F1 ◀ To set Ramp Time: 0 - 999s in 0.1s increments</p> <p>F2</p> <p>F3 ◀ To move highlighted box to FALL.</p> <p>F4</p>	
STEP 3/3	AC	LOW	: 3.00mA	INC.																														
VOLT	: 2.750kV	ARC	: OFF	DEC.																														
HIGH	: 15.00mA	RAMP	: OFF	NEXT																														
TIME	: 10.0s	FALL	: OFF	EXIT																														
<table border="1" style="width: 100%; border-collapse: collapse;"> <tr> <td style="width: 25%;">0 - 999s 0 = OFF</td> <td style="width: 10%;">RMT</td> <td style="width: 10%;">LOCK</td> <td style="width: 10%;">OFST</td> <td style="width: 10%;">ERR</td> <td style="width: 10%;">EXIT</td> </tr> </table>					0 - 999s 0 = OFF	RMT	LOCK	OFST	ERR	EXIT																								
0 - 999s 0 = OFF	RMT	LOCK	OFST	ERR	EXIT																													
Set Fall Time	<table border="1" style="width: 100%; border-collapse: collapse;"> <tr> <td style="text-align: center;">STEP 3/3</td> <td style="text-align: center;">AC</td> <td>LOW</td> <td>: 3.00mA</td> <td style="text-align: center;">INC.</td> </tr> <tr> <td>VOLT</td> <td>: 2.750kV</td> <td>ARC</td> <td>: OFF</td> <td style="text-align: center;">DEC.</td> </tr> <tr> <td>HIGH</td> <td>: 15.00mA</td> <td>RAMP</td> <td>: 3.0s</td> <td style="text-align: center;">NEXT</td> </tr> <tr> <td>TIME</td> <td>: 10.0s</td> <td>FALL</td> <td>: OFF</td> <td style="text-align: center;">EXIT</td> </tr> <tr> <td colspan="5" style="text-align: center;"> <table border="1" style="width: 100%; border-collapse: collapse;"> <tr> <td style="width: 25%;">0 - 999s 0 = OFF</td> <td style="width: 10%;">RMT</td> <td style="width: 10%;">LOCK</td> <td style="width: 10%;">OFST</td> <td style="width: 10%;">ERR</td> <td style="width: 10%;">EXIT</td> </tr> </table> </td> </tr> </table>	STEP 3/3	AC	LOW	: 3.00mA	INC.	VOLT	: 2.750kV	ARC	: OFF	DEC.	HIGH	: 15.00mA	RAMP	: 3.0s	NEXT	TIME	: 10.0s	FALL	: OFF	EXIT	<table border="1" style="width: 100%; border-collapse: collapse;"> <tr> <td style="width: 25%;">0 - 999s 0 = OFF</td> <td style="width: 10%;">RMT</td> <td style="width: 10%;">LOCK</td> <td style="width: 10%;">OFST</td> <td style="width: 10%;">ERR</td> <td style="width: 10%;">EXIT</td> </tr> </table>					0 - 999s 0 = OFF	RMT	LOCK	OFST	ERR	EXIT	<p>F1 ◀ To set Fall Time: 0 - 999s in 0.1s increments</p> <p>F2</p> <p>F3 ◀ To move highlighted box to STEP.</p> <p>F4</p>	
STEP 3/3	AC	LOW	: 3.00mA	INC.																														
VOLT	: 2.750kV	ARC	: OFF	DEC.																														
HIGH	: 15.00mA	RAMP	: 3.0s	NEXT																														
TIME	: 10.0s	FALL	: OFF	EXIT																														
<table border="1" style="width: 100%; border-collapse: collapse;"> <tr> <td style="width: 25%;">0 - 999s 0 = OFF</td> <td style="width: 10%;">RMT</td> <td style="width: 10%;">LOCK</td> <td style="width: 10%;">OFST</td> <td style="width: 10%;">ERR</td> <td style="width: 10%;">EXIT</td> </tr> </table>					0 - 999s 0 = OFF	RMT	LOCK	OFST	ERR	EXIT																								
0 - 999s 0 = OFF	RMT	LOCK	OFST	ERR	EXIT																													
Set Next Test Step	<table border="1" style="width: 100%; border-collapse: collapse;"> <tr> <td style="text-align: center;">STEP</td> <td style="text-align: center;">3/3</td> <td style="text-align: center;">AC</td> <td>LOW</td> <td>: 3.00mA</td> <td style="text-align: center;">NEW</td> </tr> <tr> <td>VOLT</td> <td>: 2.750kV</td> <td>ARC</td> <td>: OFF</td> <td style="text-align: center;">MORE..</td> </tr> <tr> <td>HIGH</td> <td>: 15.00mA</td> <td>RAMP</td> <td>: 3.0s</td> <td style="text-align: center;">NEXT</td> </tr> <tr> <td>TIME</td> <td>: 10.0s</td> <td>FALL</td> <td>: 3.0s</td> <td style="text-align: center;">EXIT</td> </tr> <tr> <td colspan="5" style="text-align: center;"> <table border="1" style="width: 100%; border-collapse: collapse;"> <tr> <td style="width: 25%;">1 - 10</td> <td style="width: 10%;">RMT</td> <td style="width: 10%;">LOCK</td> <td style="width: 10%;">OFST</td> <td style="width: 10%;">ERR</td> <td style="width: 10%;">EXIT</td> </tr> </table> </td> </tr> </table>	STEP	3/3	AC	LOW	: 3.00mA	NEW	VOLT	: 2.750kV	ARC	: OFF	MORE..	HIGH	: 15.00mA	RAMP	: 3.0s	NEXT	TIME	: 10.0s	FALL	: 3.0s	EXIT	<table border="1" style="width: 100%; border-collapse: collapse;"> <tr> <td style="width: 25%;">1 - 10</td> <td style="width: 10%;">RMT</td> <td style="width: 10%;">LOCK</td> <td style="width: 10%;">OFST</td> <td style="width: 10%;">ERR</td> <td style="width: 10%;">EXIT</td> </tr> </table>					1 - 10	RMT	LOCK	OFST	ERR	EXIT	<p>F1 ◀ To set next test step = 4</p> <p>F2</p> <p>F3</p> <p>F4 ◀ To exit programming mode and return to STAND BY status.</p>
STEP	3/3	AC	LOW	: 3.00mA	NEW																													
VOLT	: 2.750kV	ARC	: OFF	MORE..																														
HIGH	: 15.00mA	RAMP	: 3.0s	NEXT																														
TIME	: 10.0s	FALL	: 3.0s	EXIT																														
<table border="1" style="width: 100%; border-collapse: collapse;"> <tr> <td style="width: 25%;">1 - 10</td> <td style="width: 10%;">RMT</td> <td style="width: 10%;">LOCK</td> <td style="width: 10%;">OFST</td> <td style="width: 10%;">ERR</td> <td style="width: 10%;">EXIT</td> </tr> </table>					1 - 10	RMT	LOCK	OFST	ERR	EXIT																								
1 - 10	RMT	LOCK	OFST	ERR	EXIT																													

[F1] : Program Step 4
or
[F4] : Exit Program Mode

END AC Hipot Test Programming. After selecting the FALL Time, one can either press [F1] = NEW to change the step number in the highlighted box (1-10) and start programming STEP 4-10, **OR** one can press [F4] = EXIT to exit programming function and return to STAND BY status.

For this example, press [F1] = NEW and proceed to program step 4 as a DC Hipot Test (¶ 2.7).

2.7 Programming a DC Hipot Test

This test is applicable to the Sentry 20 and 30 Plus instruments. With the instrument in 'stand-by' status, press [F1] = PROGRAM. If continuing the 6-step example from ¶2.6, you are already in program mode and on the AC test mode page. The example illustrated herein shows a GC test as Step 1, an AC test as Step 2 and how to program a DC test in Step 3. Follow the **green** arrows (→) on the right side of this diagram to program the individual DC hipot test parameters.

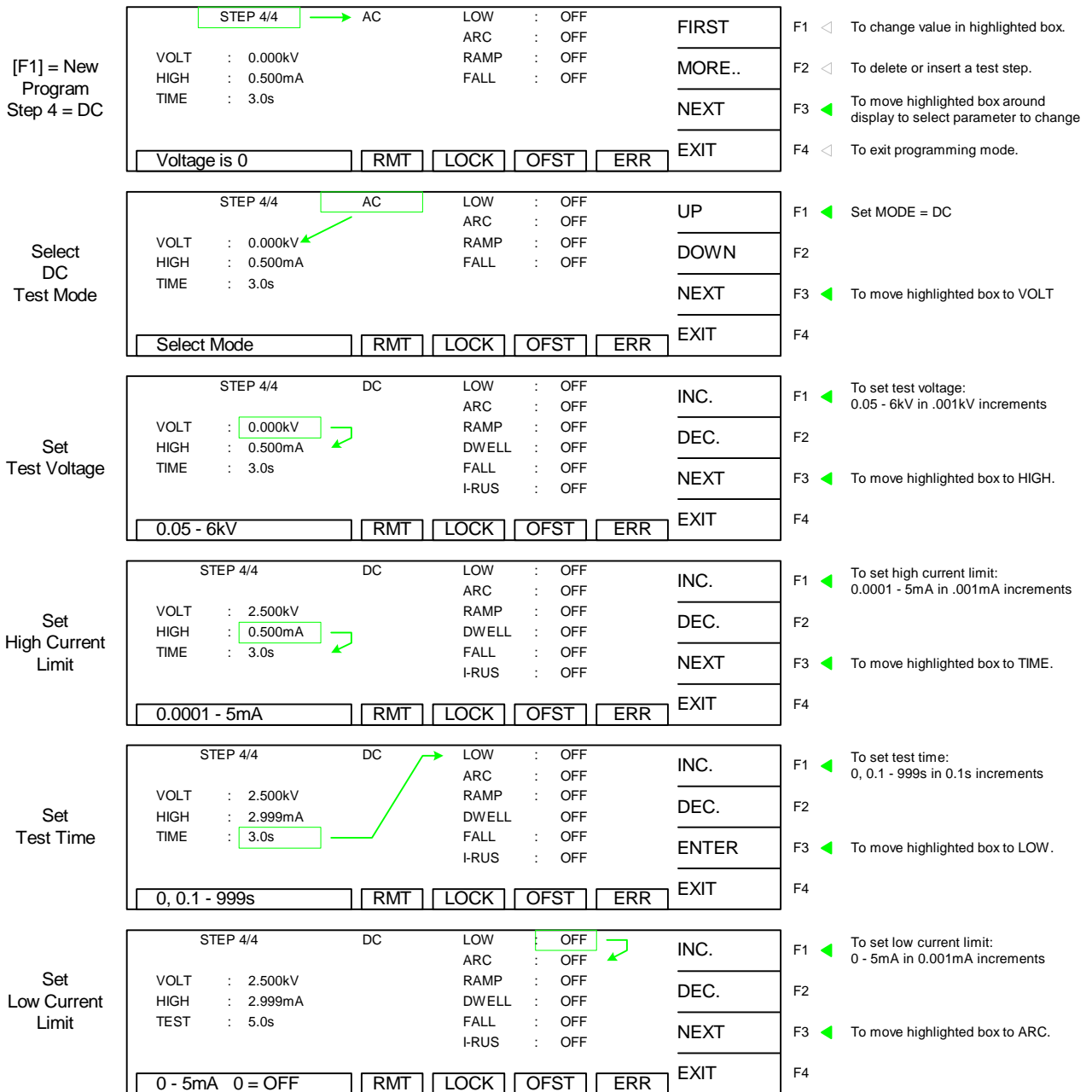

Continue on next page.

Programming an DC Hipot Test (Continued)

Set Arc Limit	STEP 4/4	DC	LOW : 0.015mA	INC.	F1	Set arc current limit: 1-5mA in 0.1mA increments
	VOLT : 2.500kV		ARC : OFF	DEC.	F2	
	HIGH : 2.999mA		RAMP : OFF	NEXT	F3	To move highlighted box to RAMP.
	TIME : 5.0s		DWELL : OFF	EXIT	F4	
			FALL : OFF			
			I-RUS : OFF			
Set Ramp Time	STEP 4/4	DC	LOW : 0.015mA	INC.	F1	To set Ramp Time: 0 - 999s in 0.1s increments
	VOLT : 2.500kV		ARC : OFF	DEC.	F2	
	HIGH : 2.999mA		RAMP : OFF	NEXT	F3	To move highlighted box to DWELL.
	TIME : 5.0s		DWELL : OFF	EXIT	F4	
			FALL : OFF			
			I-RUS : OFF			
Set Dwell Time	STEP 4/4	DC	LOW : 0.015mA	INC.	F1	To set Dwell Time: 0 - 999s in 0.1s increments
	VOLT : 2.500kV		ARC : OFF	DEC.	F2	
	HIGH : 2.999mA		RAMP : 3.0s	NEXT	F3	To move highlighted box to FALL.
	TIME : 5.0s		DWELL : OFF	EXIT	F4	
			FALL : OFF			
			I-RUS : OFF			
Set Fall Time	STEP 4/4	DC	LOW : 0.015mA	INC.	F1	To set Fall Time: 0 - 999s in 0.1s increments
	VOLT : 2.500kV		ARC : OFF	DEC.	F2	
	HIGH : 2.999mA		RAMP : 3.0s	NEXT	F3	To move highlighted box to I-RUS.
	TIME : 5.0s		DWELL : 3.0s	EXIT	F4	
			FALL : OFF			
			I-RUS : OFF			
Set I-Rus Limit	STEP 4/4	DC	LOW : 0.015mA	INC.	F1	Set in-rush current limit: 0, 0.5uA -5mA in 0.001mA increments
	VOLT : 2.500kV		ARC : OFF	DEC.	F2	
	HIGH : 2.999mA		RAMP : 3.0s	NEXT	F3	To move highlighted box to STEP.
	TIME : 5.0s		DWELL : 3.0s	EXIT	F4	
			FALL : 3.0s			
			I-RUS : OFF			
Set Next Test Step	STEP 4/4	DC	LOW : 0.015mA	NEW	F1	To set next test step = 5
	VOLT : 2.500kV		ARC : OFF	MORE..	F2	
	HIGH : 2.999mA		RAMP : 3.0s	NEXT	F3	
	TIME : 5.0s		DWELL : 3.0s	EXIT	F4	To exit programming mode and return to STAND BY status.
			FALL : 3.0s			
			I-RUS : OFF			

[F1] : Program Step 5
or
[F4] : Exit Program Mode

END DC Hipot Test Programming. After selecting the I-RUSH limit, press [F1] = NEW to change the step number in the highlighted box (1-10) and start programming STEP 5-10, **OR** press [F4] = EXIT to exit programming function and return to STAND BY status.

For this example, press [F1] = NEW and proceed to program step 5 as a PA (Pause ¶ 2.8).

NOTE: In-Rush Current

The In-Rush current range is dependent on the programmed High Limit. Refer to Specifications section, page 8. The In-Rush current limit for the DC hipot test is a low limit which is monitored during initial charging of the device under test. When activated (other than Off), current below the programmed value is considered to be a Fail condition. This current monitoring is generally used to check that the charging current to the device exceeds a specified value (> programmed limit), thus ensuring that the device is properly connected to the tester.

2.8 Programming a Pause (PA) in the Test Sequence

“PAUSE” is a mode selection that allows a test sequence to be stopped while test leads are changed or other operations performed. A 15-character user programmable message will be displayed on the screen when in PAUSE mode and the test will continue when the [START] button is pressed or when START is initiated via remote I/O. The Under Test relay on the remote I/O can also be cycled during PAUSE if required. During the test sequence when PAUSE is encountered the tester stops, displays PAUSE and 15-character message until START button is pressed again (or START is initiated via remote I/O).

This mode is applicable to the Sentry 10, 20 and 30 Plus instruments. With the instrument in ‘stand-by’ status, press [F1] = PROGRAM. If continuing the 6-step example from ¶2.7, you are already in program mode and on the AC test mode page. This example shows a GC test as Step1, an OSC check as Step 2, an AC test as Step 3, a DC test as Step 4, a Pause as Step 5 and finally an IR test as Step 6. Follow the **green** arrows (□) on the right side of this diagram to program the individual Pause mode parameters. Enter a message (length 1-15 characters) for the operator.

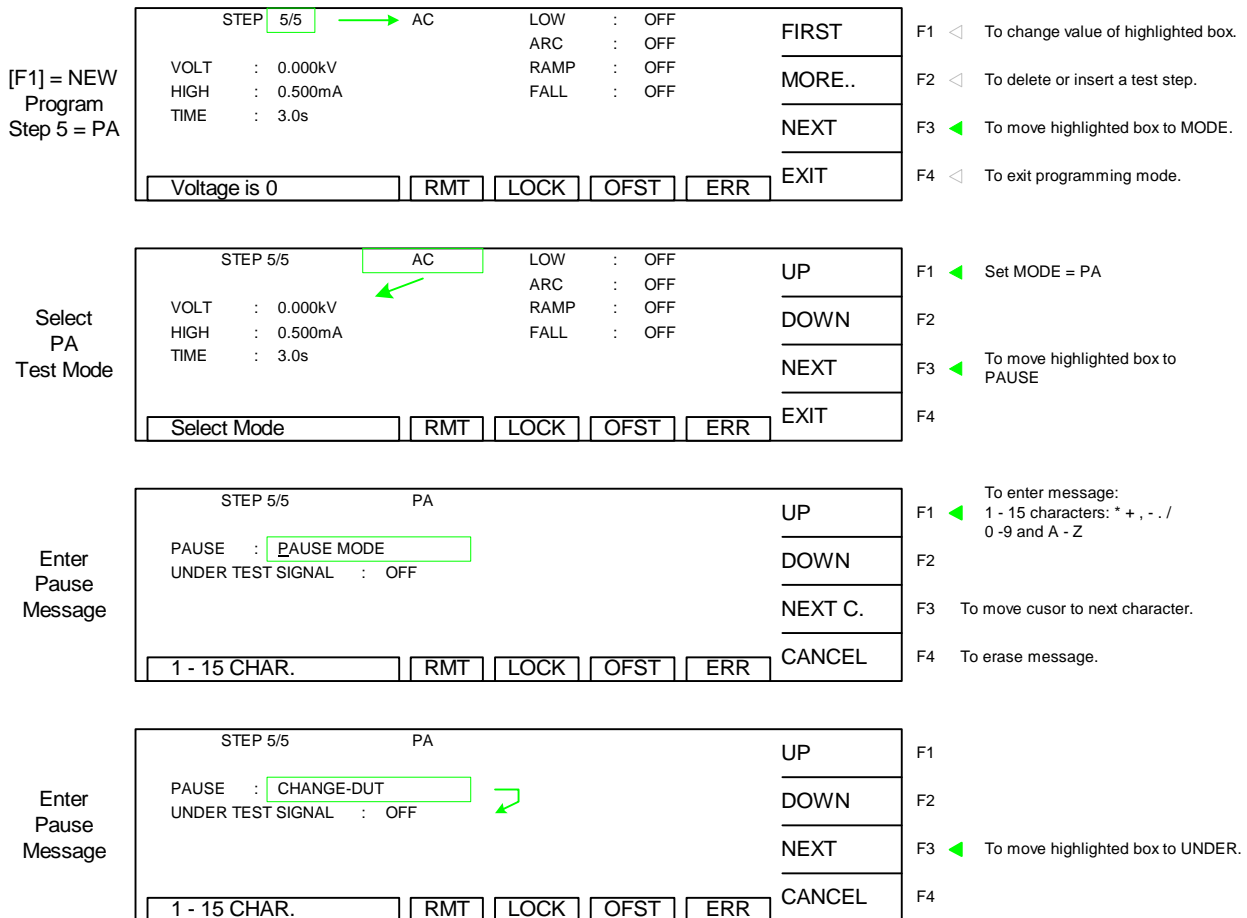

Continued on next page.

Programming a PAUSE in test sequence (continued):

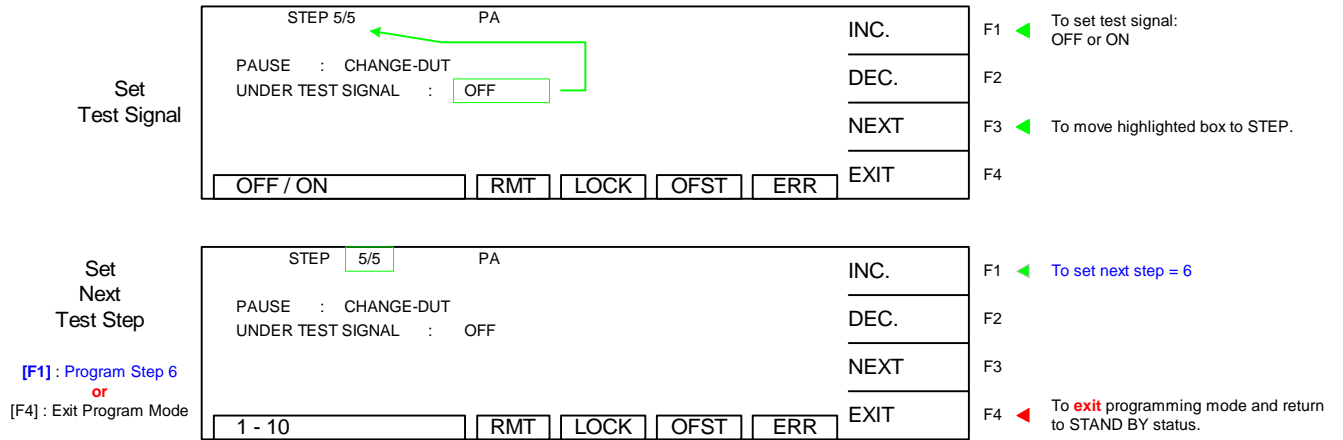

END PA Mode Programming. After selecting the Under Test Signal, one can either press [F1] = NEW to change the step number in the highlighted box (1-10) and start programming STEP 6-10, **OR** one can press [F4] = EXIT to exit programming function and return to STAND BY status.

For this example, press [F1] = NEW and proceed to program step 6 as an IR Test (¶ 2.9).

2.9 Programming an IR (Insulation Resistance) Test

This test is applicable to the Sentry 30 Plus instrument. With the instrument in ‘stand-by’ status, press [F1] = PROGRAM. If continuing the 6-step example from ¶2.8, you are already in program mode and on the AC test mode page. This example shows a GC test as Step1, an AC test as Step 2, a DC test as Step 3 and how to program an IR test in Step 4. Follow the **green** arrows (□) on the right side of this diagram to program the individual IR test parameters.

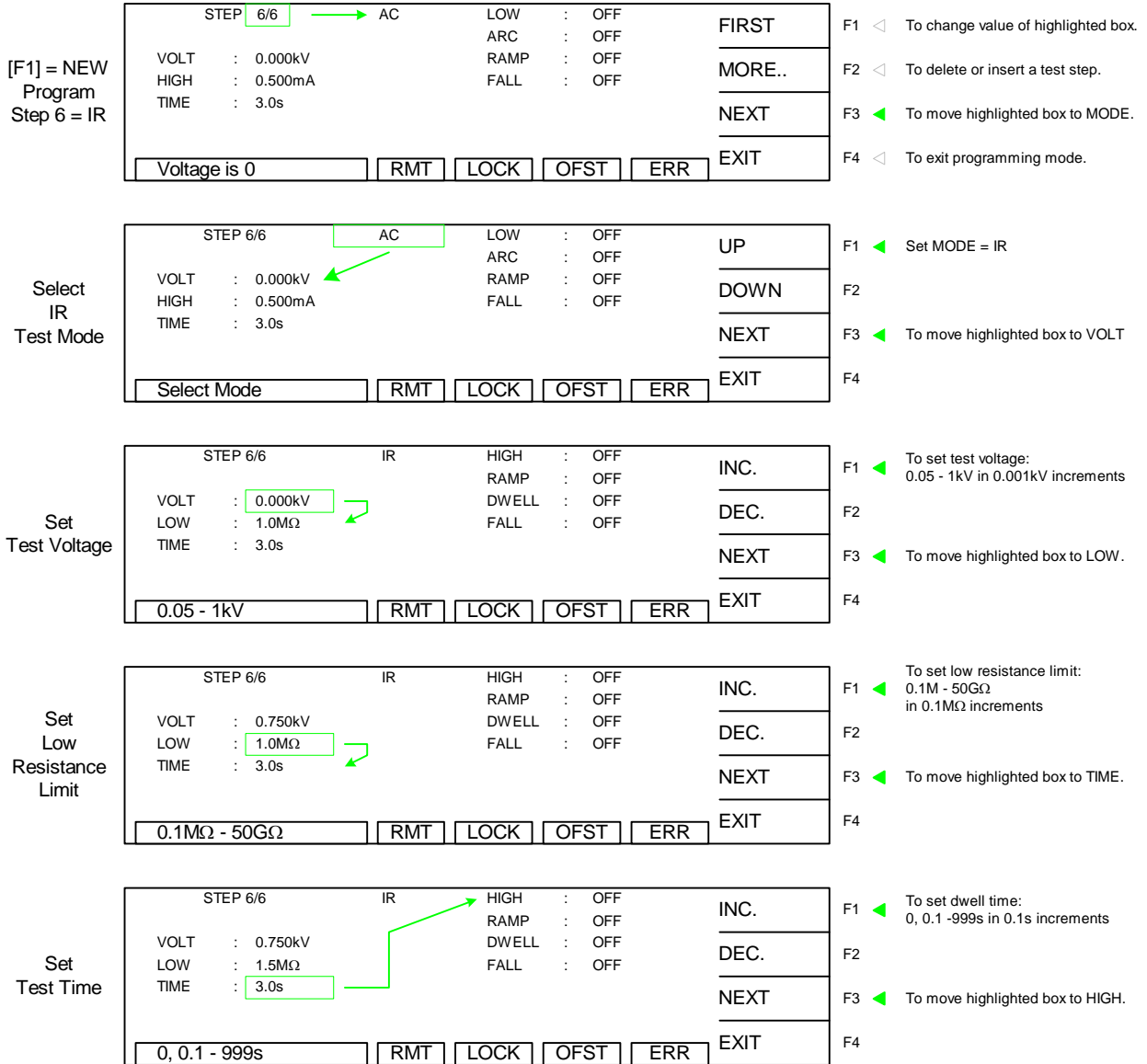

Continue on next page.

Programming an IR Test (Continued)

Set High Resistance Limit	<table border="1"> <tr> <td>STEP 6/6</td> <td>IR</td> <td>HIGH</td> <td>OFF</td> <td>INC.</td> </tr> <tr> <td>VOLT : 0.750kV</td> <td></td> <td>RAMP</td> <td>OFF</td> <td>DEC.</td> </tr> <tr> <td>LOW : 1.5MΩ</td> <td></td> <td>DWELL</td> <td>OFF</td> <td>NEXT</td> </tr> <tr> <td>TIME : 5.0s</td> <td></td> <td>FALL</td> <td>OFF</td> <td>EXIT</td> </tr> <tr> <td colspan="5">0 - 50GΩ 0 = OFF RMT LOCK OFST ERR</td> </tr> </table>	STEP 6/6	IR	HIGH	OFF	INC.	VOLT : 0.750kV		RAMP	OFF	DEC.	LOW : 1.5MΩ		DWELL	OFF	NEXT	TIME : 5.0s		FALL	OFF	EXIT	0 - 50GΩ 0 = OFF RMT LOCK OFST ERR					<p>F1 ◀ To set high resistance limit: 0 - 50GΩ in 0.1MΩ increments (from programmed low limit to 50GΩ)</p> <p>F2</p> <p>F3 ◀ To move highlighted box to RAMP.</p> <p>F4</p>					
STEP 6/6	IR	HIGH	OFF	INC.																												
VOLT : 0.750kV		RAMP	OFF	DEC.																												
LOW : 1.5MΩ		DWELL	OFF	NEXT																												
TIME : 5.0s		FALL	OFF	EXIT																												
0 - 50GΩ 0 = OFF RMT LOCK OFST ERR																																
Select Ramp Time	<table border="1"> <tr> <td>STEP 6/6</td> <td>IR</td> <td>HIGH</td> <td>1.250GΩ</td> <td>UP</td> </tr> <tr> <td>VOLT : 0.750kV</td> <td></td> <td>RAMP</td> <td>OFF</td> <td>DOWN</td> </tr> <tr> <td>LOW : 1.5MΩ</td> <td></td> <td>DWELL</td> <td>OFF</td> <td>NEXT</td> </tr> <tr> <td>TIME : 5.0s</td> <td></td> <td>FALL</td> <td>OFF</td> <td>EXIT</td> </tr> <tr> <td colspan="5">0 - 999s 0 = OFF RMT LOCK OFST ERR</td> </tr> </table>	STEP 6/6	IR	HIGH	1.250GΩ	UP	VOLT : 0.750kV		RAMP	OFF	DOWN	LOW : 1.5MΩ		DWELL	OFF	NEXT	TIME : 5.0s		FALL	OFF	EXIT	0 - 999s 0 = OFF RMT LOCK OFST ERR					<p>F1 ◀ To set ramp time: 0 - 999s in 0.1s increments</p> <p>F2</p> <p>F3 ◀ To move highlighted box to DWELL.</p> <p>F4</p>					
STEP 6/6	IR	HIGH	1.250GΩ	UP																												
VOLT : 0.750kV		RAMP	OFF	DOWN																												
LOW : 1.5MΩ		DWELL	OFF	NEXT																												
TIME : 5.0s		FALL	OFF	EXIT																												
0 - 999s 0 = OFF RMT LOCK OFST ERR																																
Select Dwell Time	<table border="1"> <tr> <td>STEP 6/6</td> <td>IR</td> <td>HIGH</td> <td>1.250GΩ</td> <td>UP</td> </tr> <tr> <td>VOLT : 0.750kV</td> <td></td> <td>RAMP</td> <td>3.0s</td> <td>DOWN</td> </tr> <tr> <td>LOW : 1.5MΩ</td> <td></td> <td>DWELL</td> <td>OFF</td> <td>NEXT</td> </tr> <tr> <td>TIME : 5.0s</td> <td></td> <td>FALL</td> <td>OFF</td> <td>EXIT</td> </tr> <tr> <td colspan="5">0 - 999s 0 = OFF RMT LOCK OFST ERR</td> </tr> </table>	STEP 6/6	IR	HIGH	1.250GΩ	UP	VOLT : 0.750kV		RAMP	3.0s	DOWN	LOW : 1.5MΩ		DWELL	OFF	NEXT	TIME : 5.0s		FALL	OFF	EXIT	0 - 999s 0 = OFF RMT LOCK OFST ERR					<p>F1 ◀ To set ramp time: 0 - 999s in 0.1s increments</p> <p>F2</p> <p>F3 ◀ To move highlighted box to FALL.</p> <p>F4</p>					
STEP 6/6	IR	HIGH	1.250GΩ	UP																												
VOLT : 0.750kV		RAMP	3.0s	DOWN																												
LOW : 1.5MΩ		DWELL	OFF	NEXT																												
TIME : 5.0s		FALL	OFF	EXIT																												
0 - 999s 0 = OFF RMT LOCK OFST ERR																																
Set Fall Time	<table border="1"> <tr> <td>STEP 6/6</td> <td>IR</td> <td>HIGH</td> <td>1.250GΩ</td> <td>INC.</td> </tr> <tr> <td>VOLT : 0.750kV</td> <td></td> <td>RAMP</td> <td>3.0s</td> <td>DEC.</td> </tr> <tr> <td>LOW : 1.5MΩ</td> <td></td> <td>DWELL</td> <td>3.0s</td> <td>NEXT</td> </tr> <tr> <td>TIME : 5.0s</td> <td></td> <td>FALL</td> <td>OFF</td> <td>EXIT</td> </tr> <tr> <td colspan="5">0 - 999s 0 = OFF RMT LOCK OFST ERR</td> </tr> </table>	STEP 6/6	IR	HIGH	1.250GΩ	INC.	VOLT : 0.750kV		RAMP	3.0s	DEC.	LOW : 1.5MΩ		DWELL	3.0s	NEXT	TIME : 5.0s		FALL	OFF	EXIT	0 - 999s 0 = OFF RMT LOCK OFST ERR					<p>F1 ◀ To set fall time: 0 - 999s in 0.1s increments</p> <p>F2</p> <p>F3 ◀ To move highlighted box to STEP.</p> <p>F4</p>					
STEP 6/6	IR	HIGH	1.250GΩ	INC.																												
VOLT : 0.750kV		RAMP	3.0s	DEC.																												
LOW : 1.5MΩ		DWELL	3.0s	NEXT																												
TIME : 5.0s		FALL	OFF	EXIT																												
0 - 999s 0 = OFF RMT LOCK OFST ERR																																
Exit Program Mode	<table border="1"> <tr> <td>STEP</td> <td>6/6</td> <td>IR</td> <td>HIGH</td> <td>1.250GΩ</td> <td>NEW</td> </tr> <tr> <td>VOLT</td> <td>: 0.750kV</td> <td></td> <td>RAMP</td> <td>: 3.0s</td> <td>MORE ..</td> </tr> <tr> <td>LOW</td> <td>: 1.5MΩ</td> <td></td> <td>DWELL</td> <td>: 3.0s</td> <td>NEXT</td> </tr> <tr> <td>TIME</td> <td>: 5.0s</td> <td></td> <td>FALL</td> <td>: 3.0s</td> <td>EXIT</td> </tr> <tr> <td colspan="6">1 - 10 RMT LOCK OFST ERR</td> </tr> </table>	STEP	6/6	IR	HIGH	1.250GΩ	NEW	VOLT	: 0.750kV		RAMP	: 3.0s	MORE ..	LOW	: 1.5MΩ		DWELL	: 3.0s	NEXT	TIME	: 5.0s		FALL	: 3.0s	EXIT	1 - 10 RMT LOCK OFST ERR						<p>F1</p> <p>F2</p> <p>F3</p> <p>F4 ◀ To exit program mode and return to STAND BY status.</p>
STEP	6/6	IR	HIGH	1.250GΩ	NEW																											
VOLT	: 0.750kV		RAMP	: 3.0s	MORE ..																											
LOW	: 1.5MΩ		DWELL	: 3.0s	NEXT																											
TIME	: 5.0s		FALL	: 3.0s	EXIT																											
1 - 10 RMT LOCK OFST ERR																																

END IR Test Programming. After selecting the FALL Time, one can either press [F1] = NEW to change the step number in the highlighted box (1-10) and start programming STEP 7-10, **OR** one can press [F4] = EXIT to exit programming function and return to STAND BY status.

For the sake of this 6-step example, press [F4] = EXIT to exit programming function and return to STAND BY status.

2.10 Storing a Test Setup

NOTE:

Instrument PRESET values can be programmed and stored for your specific test setup. Therefore before storing your tests, program the preset values. Refer to ¶ 2.12 for PRESET programming information.

To store the previous example of the programmed 6-step test, with the instrument in ‘STAND BY’ status, press [F3] = MENU to access the memory function.

In MENU with the highlighted box around **MEMORY**, press [F3] = SELECT to enter the memory function.

STAND BY Display	<table border="1"> <tr> <td>STEP 1/6</td> <td>GC</td> <td>LOW</td> <td>: 0.3Ω</td> <td>PROGRAM</td> <td>F1 ◀ To enter programming mode.</td> </tr> <tr> <td>0.1A</td> <td></td> <td></td> <td></td> <td>PRESET</td> <td>F2 ◀ To view/change preset (initial) test parameters.</td> </tr> <tr> <td>1.2Ω</td> <td></td> <td></td> <td></td> <td>MENU</td> <td>F3 ◀ To view/change system parameters: memory, system, option, calibration, key lock, password, error, & about.</td> </tr> <tr> <td>0.5s</td> <td></td> <td></td> <td></td> <td>MORE..</td> <td>F4 ◀ To view the programmed test setups and access offset function.</td> </tr> <tr> <td></td> <td>STAND BY</td> <td>RMT</td> <td>LOCK</td> <td>OFST</td> <td>ERR</td> <td></td> </tr> </table>	STEP 1/6	GC	LOW	: 0.3Ω	PROGRAM	F1 ◀ To enter programming mode.	0.1A				PRESET	F2 ◀ To view/change preset (initial) test parameters.	1.2Ω				MENU	F3 ◀ To view/change system parameters: memory, system, option, calibration, key lock, password, error, & about.	0.5s				MORE..	F4 ◀ To view the programmed test setups and access offset function.		STAND BY	RMT	LOCK	OFST	ERR	
	STEP 1/6	GC	LOW	: 0.3Ω	PROGRAM	F1 ◀ To enter programming mode.																										
	0.1A				PRESET	F2 ◀ To view/change preset (initial) test parameters.																										
	1.2Ω				MENU	F3 ◀ To view/change system parameters: memory, system, option, calibration, key lock, password, error, & about.																										
0.5s				MORE..	F4 ◀ To view the programmed test setups and access offset function.																											
	STAND BY	RMT	LOCK	OFST	ERR																											
MENU	<table border="1"> <tr> <td>1</td> <td>MEMORY</td> <td>LAST</td> <td>F1 ◀ To toggle through MENU functions.</td> </tr> <tr> <td>2</td> <td>SYSTEM</td> <td>DOWN</td> <td>F2 ◀ To toggle through MENU functions.</td> </tr> <tr> <td>3</td> <td>OPTION</td> <td>SELECT</td> <td>F3 ◀ To enter MEMORY function.</td> </tr> <tr> <td>4</td> <td>CALIBRATION</td> <td>EXIT</td> <td>F4 ◀ Return to STAND BY display.</td> </tr> <tr> <td>5</td> <td>KEY LOCK</td> <td></td> <td></td> </tr> <tr> <td></td> <td>SELECT FUNC.</td> <td>RMT</td> <td>LOCK</td> <td>OFST</td> <td>ERR</td> <td></td> </tr> </table>	1	MEMORY	LAST	F1 ◀ To toggle through MENU functions.	2	SYSTEM	DOWN	F2 ◀ To toggle through MENU functions.	3	OPTION	SELECT	F3 ◀ To enter MEMORY function.	4	CALIBRATION	EXIT	F4 ◀ Return to STAND BY display.	5	KEY LOCK				SELECT FUNC.	RMT	LOCK	OFST	ERR					
	1	MEMORY	LAST	F1 ◀ To toggle through MENU functions.																												
	2	SYSTEM	DOWN	F2 ◀ To toggle through MENU functions.																												
	3	OPTION	SELECT	F3 ◀ To enter MEMORY function.																												
4	CALIBRATION	EXIT	F4 ◀ Return to STAND BY display.																													
5	KEY LOCK																															
	SELECT FUNC.	RMT	LOCK	OFST	ERR																											
MEMORY	<table border="1"> <tr> <td>1</td> <td>(0 STEPS)</td> <td>STORE</td> <td>F1 ◀ To store a test setup in memory location 1-60</td> </tr> <tr> <td>2</td> <td>(0 STEPS)</td> <td>RECALL</td> <td>F2 ◀ Recall test in highlighted location.</td> </tr> <tr> <td>3</td> <td>(0 STEPS)</td> <td>DELETE</td> <td>F3 ◀ Delete test in highlighted location.</td> </tr> <tr> <td>4</td> <td>(0 STEPS)</td> <td>RETURN</td> <td>F4 ◀ Return to MENU display.</td> </tr> <tr> <td>5</td> <td>(0 STEPS)</td> <td></td> <td></td> </tr> <tr> <td></td> <td>SELECT FUNC.</td> <td>RMT</td> <td>LOCK</td> <td>OFST</td> <td>ERR</td> <td></td> </tr> </table>	1	(0 STEPS)	STORE	F1 ◀ To store a test setup in memory location 1-60	2	(0 STEPS)	RECALL	F2 ◀ Recall test in highlighted location.	3	(0 STEPS)	DELETE	F3 ◀ Delete test in highlighted location.	4	(0 STEPS)	RETURN	F4 ◀ Return to MENU display.	5	(0 STEPS)				SELECT FUNC.	RMT	LOCK	OFST	ERR					
	1	(0 STEPS)	STORE	F1 ◀ To store a test setup in memory location 1-60																												
	2	(0 STEPS)	RECALL	F2 ◀ Recall test in highlighted location.																												
	3	(0 STEPS)	DELETE	F3 ◀ Delete test in highlighted location.																												
4	(0 STEPS)	RETURN	F4 ◀ Return to MENU display.																													
5	(0 STEPS)																															
	SELECT FUNC.	RMT	LOCK	OFST	ERR																											

Press [F1] = STORE to access the store function. Press [F2] = DOWN to move highlighted box to the memory location (1-60) in which you wish to store this test setup. Press [F3] = SELECT to accept location number.

Select LOCATION	<table border="1"> <tr> <td>1</td> <td>(0 STEPS)</td> <td>LAST</td> <td>F1 ◀ To move highlighted box to memory location 60</td> </tr> <tr> <td>2</td> <td>(0 STEPS)</td> <td>DOWN</td> <td>F2 ◀ To toggle through memory locations 1-60</td> </tr> <tr> <td>3</td> <td>(0 STEPS)</td> <td>SELECT</td> <td>F3 ◀ To select highlighted memory location and store previously programmed test setup</td> </tr> <tr> <td>4</td> <td>(0 STEPS)</td> <td>RETURN</td> <td>F4</td> </tr> <tr> <td>5</td> <td>(0 STEPS)</td> <td></td> <td></td> </tr> <tr> <td></td> <td>SEL. MEMORY</td> <td>RMT</td> <td>LOCK</td> <td>OFST</td> <td>ERR</td> <td></td> </tr> </table>	1	(0 STEPS)	LAST	F1 ◀ To move highlighted box to memory location 60	2	(0 STEPS)	DOWN	F2 ◀ To toggle through memory locations 1-60	3	(0 STEPS)	SELECT	F3 ◀ To select highlighted memory location and store previously programmed test setup	4	(0 STEPS)	RETURN	F4	5	(0 STEPS)				SEL. MEMORY	RMT	LOCK	OFST	ERR	
	1	(0 STEPS)	LAST	F1 ◀ To move highlighted box to memory location 60																								
	2	(0 STEPS)	DOWN	F2 ◀ To toggle through memory locations 1-60																								
	3	(0 STEPS)	SELECT	F3 ◀ To select highlighted memory location and store previously programmed test setup																								
4	(0 STEPS)	RETURN	F4																									
5	(0 STEPS)																											
	SEL. MEMORY	RMT	LOCK	OFST	ERR																							

To label the selected location, press [F1] = UP (and/or [F2] = DOWN) to enter a combination alpha-numeric name for this test setup. Press [F3] = NEXT C. after each digit to accept that digit and move on to the next. The name can be up to 10 characters long. When finished entering the name, press [F3] = ENTER two times.

LABEL Test Setup	1	(0 STEPS) _	UP	F1	◀ To enter an alpha-numeric character			
	2	(0 STEPS)	DOWN	F2	◀ To enter an alpha-numeric character			
	3	(0 STEPS)	NEXT C.	F3	◀ Accept entered character and move on to next character			
	4	(0 STEPS)	CANCEL	F4	◀			
	5	(0 STEPS)						
		SELECT FUNC.	RMT	LOCK	OFST	ERR		

Exit Label Function	1	(0 STEPS) 123	UP	F1	◀			
	2	(0 STEPS)	DOWN	F2	◀			
	3	(0 STEPS)	NEXT C.	F3	◀ Press 2 Times to exit LABEL function			
	4	(0 STEPS)	CANCEL	F4				
	5	(0 STEPS)						
		SEL. MEMORY	RMT	LOCK	OFST	ERR		

The display will prompt: STORE TO #? Press [F1] = YES to accept storage to that memory location # or [F2] = NO to reject storage. Press [F4] = RETURN once to return to “MENU” display. Press [F4] a second time to return to “STAND BY” display.

Confirm STORE	1	(0 STEPS) 123	YES	F1	◀ Store test setup to location #1			
	2	(0 STEPS)	NO	F2				
	3	(0)		F3				
	4	(0) STORE TO 1?		F4				
	5	(0)						
			RMT	LOCK	OFST	ERR		

MEMORY	1	(5 STEPS) 123	STORE	F1				
	2	(0 STEPS)	RECALL	F2				
	3	(0 STEPS)	DELETE	F3				
	4	(0 STEPS)	RETURN	F4	◀ Return to MENU display.			
	5	(0 STEPS)						
		SELECT FUNC.	RMT	LOCK	OFST	ERR		

STAND BY Display with Memory ID	M01	1/6	GC	LOW	: 0.3Ω	PROGRAM	F1
	0.1A					PRESET	F2
	1.2Ω					MENU	F3
	0.5s					MORE..	F4
	STAND BY		RMT	LOCK	OFST	ERR	

The MEMORY RECALL and DELETE functions work the same way as STORE. When the instrument returns to STAND BY status there will be a tag “Mxx” in the upper left hand corner of the display to indicate which memory location is in use (displayed).

2.11 Programming a Multi-Step Test

Paragraphs 2.4, 2.5, 2.6, 2.7, 2.8 and 2.9 illustrate the programming of a 6-step test (GC, OSC, AC, DC, PA & IR). To program a multiple step test, power-up the Sentry Plus Series instrument so the ‘Stand By’ display is shown (Figure 2-2). Press [F1] = PROGRAM and enter the test parameters for the first test (GC). After specifying LOW resistance limit, press [F3] = NEXT and [F1] = NEW to enter test parameters for the second test (AC). At this time, do **NOT** press [F4] = EXIT because this will exit you from programming mode. After specifying FALL time for the second test press [F3] = NEXT to continue entering test parameters for the third test (DC). Continue this process for up to 10 steps. When finished entering desired number of test steps, press [F4] = EXIT to exit programming mode and return to Stand By status.

In Stand By status, to view the test steps just programmed press [F4] = MORE. Figure 2-5 illustrates the Stand By display and resultant test steps display if the programming example in paragraphs 2.4-2.9 was followed.

STAND BY with Memory ID

M01	1/6	GC	LOW	: 0.3Ω	PROGRAM	F1
		0.1A			PRESET	F2
		1.2Ω			MENU	F3
		0.5s			MORE..	F4
STAND BY					RMT	LOCK
					OFST	ERR

Continuing with the 6-step example, press [F4] = MORE to view the 6 test steps (GC, OS, AC, DC, PA & IR) stored to location 1.

Test Steps

M01	OUTPUT	MEASURE	RESULT	OFFSET	F1
1	GC	0.1A	1.2Ω	-----	
2	OS	0.100kV	0.0nF	-----	GET Cs
3	AC	2.750kV	15.00mA	-----	
4	DC	2.500kV	2.999mA	-----	
5	PA	PAUSE MODE		-----	
STAND BY					MORE...
					RMT
					LOCK
					OFST
					ERR

Press [F4] = MORE

Test Steps

M01	OUTPUT	MEASURE	RESULT	LAST	F1
1	GC	0.1A	1.2Ω	-----	
2	OS	0.100kV	0.0nF	-----	DOWN
3	AC	2.750kV	15.00mA	-----	
4	DC	2.500kV	2.999mA	-----	
5	PA	PAUSE MODE		-----	
STAND BY					MORE...
					RMT
					LOCK
					OFST
					ERR

Press [F2] = DOWN

Test Steps

M01	OUTPUT	MEASURE	RESULT	UP	F1
2	OS	0.1A	0.nF	-----	
3	AC	2.750kV	15.00mA	-----	FIRST
4	DC	2.500kV	2.999mA	-----	
5	PA	PAUSE MODE		-----	
6	IR	0.750kV	1.5MΩ	-----	
STAND BY					EXIT
					RMT
					LOCK
					OFST
					ERR

Figure 2-5: View Programmed Test Setups

2.12 PRESET Test Parameters

A number of initial parameters or default conditions may be programmed and stored as the 'power-up' conditions. On the Sentry Plus Series instruments, this function is labeled PRESET and is accessible on the STAND BY display.

The PRESET values are stored with each programmed test. Therefore each memory location may have different PRESET values. It is important to set the PRESET values prior to storing a test program.

Table 2-3 lists the Sentry Plus Series PRESET test parameters including parameter range and initial (default) value.

Table 2-3: PRESET Test Parameters

Parameter	Range	Initial (Default) Value	Description
AC-V FREQ.	50 or 60Hz	60Hz	Set frequency for AC Hipot test
SOFT. AGC	ON or OFF	ON	Set software automatic gain control function ON or OFF
WV AUTO RANGE	ON or OFF	OFF	Set hipot auto range function ON or OFF
IR AUTO RANGE	ON or OFF	ON	Set resistance auto range function ON or OFF
GFI	ON or OFF	ON	Set ground fault interrupt to trip at 0.5mA
FAIL RESTART	ON or OFF	OFF	Fail continue steps

2.12.1 AC-V FREQ.

The AC-V Frequency setting allows the user to select the line frequency for the AC hipot test. The range of AC-V Freq. is 50 or 60Hz and the instrument default setting is 60Hz.

2.12.2 SOFTWARE AGC

The Software Automatic Gain Control (SOFT AGC) setting allows the option of correcting the output voltage when ON. This is satisfactory when measuring resistors but under special circumstances when measuring large capacitive devices it is best to select Software AGC OFF. The default value is ON.

2.12.3 WV AUTO RANGE

The WV Auto Range setting allows the option of using the full scale current range (ON) or using the user programmed maximum current limit (OFF) during a withstand voltage (hipot) test. The low current range (3mA full scale) results in increased measurement resolution. The default value of WV Auto Range is OFF.

2.12.4 IR AUTO RANGE

The IR Auto Range setting allows the option of using the full scale current range (ON) or using the user programmed maximum current limit (OFF). To increase measurement resolution in IR mode, select IR Auto Range ON. To increase measurement speed in IR mode, select IR Auto Range OFF. The instrument default value for IR Auto Range is ON.

2.12.5 GFI

The Ground Fault Interrupt (GFI) function can be programmed ON or OFF and the instrument default setting is ON. When GFI is activated, the ground fault interrupt circuit detects leakage current to ground. If the leakage is $>0.5\text{mA}$, the high voltage will be shut down in less than 0.5ms.

NOTE:

When using the Sentry Plus instrument with the Sentry 50 Ground Bond Tester,
GFI must be turned OFF.

2.12.6 FAIL RESTART

The FAIL RESTART function can be programmed ON or OFF and the instrument default setting is OFF. When the Fail Restart function is turned ON, the Sentry Plus instrument does not require the STOP button to be pressed to restart the test. This mode is typically used in conjunction with the remote I/O connections to automatically restart the test when a failure occurs. This can be done by connecting one Fail contact (pin 8) to the Start contact (pin 5) and the other Fail contact (pin 9) to the COM contact (pin 3).

2.13 Instrument Offset

The Sentry Plus Series instrument provides automatic offset for lead and/or fixture effects. During the offset process a correction is made (subtracted out) as the result of the measured current with no DUT attached. For maximum measurement accuracy it is recommended that the OFFSET function be performed on the Sentry Plus Series instrument after power up, any time the test parameters are changed and any time the test leads or fixture is changed. Return and HV test leads should not be connected together (open circuit) for AC and DC hipot tests.

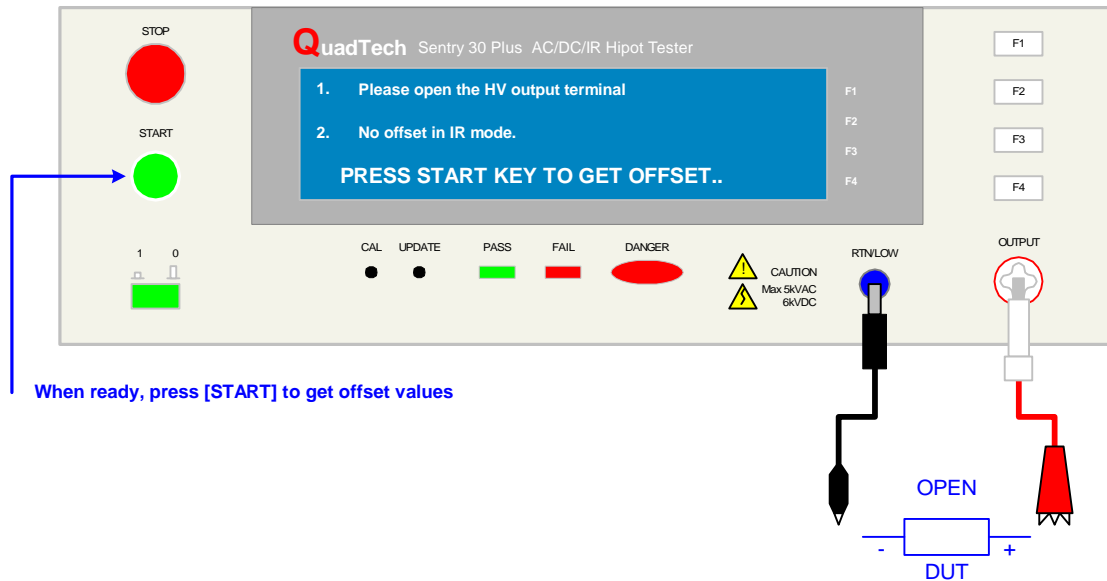

Figure 2-6: Open Leads

For a GC test, the Return and the GC test leads should be connected as a short circuit. The figure below shows the back of the unit, with the RTN/Low lead on the left and the GC lead on the right. The GC offset test can be run with the RTN/Low lead connected to the front RTN/Low port. There is no offset in an IR test.

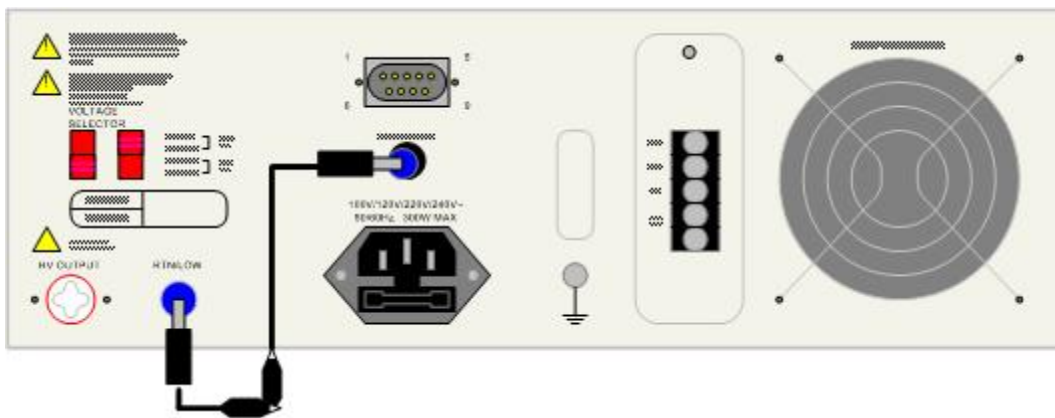

Figure 2-7: Shorted Leads: RTN/Low to GC

Once the Offset function is turned ON for a specific program, it can be stored in memory with that program. If the program parameters are changed the offset function will automatically turn OFF and the offset function must be performed again to get the new offset value. It will then need to be restored in memory.

Prior to performing the OFFSET function:

- Allow the instrument to warm up for 15 minutes.
- Connect the Test cables (or fixture) to the OUTPUT and RTN/LOW connectors.
- Program the test steps.

With the instrument in STAND BY status:

- Press [F4] = MORE
- Press [F3] = OFFSET
- Follow instructions on display: i.e.: connect OPEN across OUTPUT terminal.
- Press green [START] button.
- Wait while instrument gets OFFSET value.
- The **OFST** block at the bottom of the display is now highlighted (back lit).
- Press [F4] = MORE to return to STAND BY status.

- **OR**

To undo the OFFSET function:

- Press [F3] = OFFSET
- Follow prompt on display: “Turn off the offset function?”
- Press [F3] = ENTER to turn **off** OFFSET function.
- The **OFST** block at the bottom of the display is **not** highlighted now.

The following formulas apply to the offset function:

For Offset Current $\leq 100\mu\text{A}$:

$$\text{Display Current} = \sqrt{\left(\text{Measured Total Current}\right)^2 - \left(\text{Offset Total Current}\right)^2}$$

For Offset Current $> 100\mu\text{A}$:

$$\text{Display Current} = \left(\text{Measured Total Current}\right) - \left(\text{Offset Total Current}\right)$$

OFFSET Function

There is no offset in the IR, PA or OSC modes. Using the pre-programmed example from paragraphs 2.4-2.9 of the GC, OS, AC, DC, PA & IR 6-step test the resultant error and correction is illustrated herein.

"STAND BY" Display with Memory ID	M01 STEP 1/5 GC LOW : 0.3Ω	PROGRAM	F1
	0.1A	PRESET	F2
	1.2Ω	MENU	F3
	0.5s	MORE..	F4
	STAND BY RMT LOCK OFST ERR		F4
MORE..	M01 OUTPUT MEASURE RESULT	OFFSET	F1
	1 GC 0.1A 1.2Ω -----	GET Cs	F2
	2 OS 0.100kV 0.0nF -----		F3
	3 AC 2.750kV 15.00mA -----		F4
4 DC 2.500kV 2.999mA -----			
5 PA PAUSE MODE -----	MORE...		
	STAND BY RMT LOCK OFST ERR		F4
GET OFFSET	1. PLEASE OPEN THE HV OUTPUT TERMINAL.		F1
	2. NO OFFSET IN IR MODE.		F2
	PRESS TEST KEY TO GET OFFSET..		F3
		CANCEL	F4
	RMT LOCK OFST ERR		
OFFSET VALUES	M01 OUTPUT MEASURE RESULT	OFFSET	F1
	1 GC 0.1A UUUUUΩ PASS	GET Cs	F2
	2 OS 0.100kV 0.062nF PASS		F3
	3 AC 2.750kV 0.11mA PASS		F4
4 DC 2.500kV 0.002mA PASS			
5 PA PAUSE MODE	MORE...		
	U.T.S = OFF RMT LOCK OFST ERR		F4
			F4
GET OFFSET	M01 56 PA		F1
	1. PAUSE: PAUSE MODE		F2
	2. UNDER TEST SIGNAL: OFF		F3
	PRESS TEST KEY TO CONTINUE..		F4
	U.T.S = OFF RMT LOCK OFST ERR	MORE..	
PASS Screen	M01 6/6 IR HIGH : 1.250GΩ	PROGRAM	F1
	0.750kV RAMP : 3.0s	PRESET	F2
	1.5MΩ	MENU	F3
	0.0s	MORE..	F4
	PASS RMT LOCK OFST ERR		

▶ To access OFFSET function.
▶ To enter OFFSET function.
● To GET OFFSET values
▶ 2 Times
●

After PASS Screen, press [STOP] and screen reverts to STAND BY display. Continue on Next Page.

Offset (continued)

To turn to Offset function OFF, and return to STAND BY status, follow the screens herein.

STAND BY

M01	1/6	GC	LOW	: 0.3Ω	PROGRAM	F1	
0.1A						PRESET	F2
1.2Ω						MENU	F3
0.5s						MORE..	F4
STAND BY		RMT	LOCK	OFST	ERR		

6-Steps Programmed
Offset ON
Ready to Test

MORE..

M01	OUTPUT	MEASURE	RESULT	OFFSET	F1	
2	OS	0.068kV	0.062nF	PASS		
3	AC	2.751kV	0.11mA	PASS		
4	DC	2.500kV	0.002mA	PASS		
5	PA	PAUSE MODE		PASS		
6	IR	0.750kV	1.5MΩ	SKIPPED		
TIME : 0.0s					MORE..	F4
PASS		RMT	LOCK	OFST	ERR	

Select Offset function

OFFSET

M01	6/6	IR	OFF	F1	
1. PLEASE OPEN THE H.V. OUTPUT TERMINAL.				F2	
2. NO OFFSET IN IR MODE.				F3	
CANCEL				F4	
		RMT	LOCK	OFST	ERR

Turn Offset OFF
Go to Results page

OFFSET CLEAR

M01	OUTPUT	MEASURE	RESULT	OFFSET	F1	
1	GC	0.1A	1.2Ω	-----		
2	OS	0.100kV	0.0nF	-----		
3	AC	2.750kV	15.00mA	-----		
4	DC	2.500kV	2.999mA	-----		
5	PA	PAUSE MODE		-----		
STANDBY					MORE..	F4
		RMT	LOCK	OFST	ERR	

2 Times

STAND BY

M01	STEP 1/6	GC	LOW	: 0.3Ω	PROGRAM	F1	
0.1A						PRESET	F2
1.2Ω						MENU	F3
0.5s						MORE..	F4
STAND BY		RMT	LOCK	OFST	ERR		

6-Steps Programmed
Offset OFF
Ready to Test

End Offset Function.

2.14 Connection to Device under Test

Figure 2-8 illustrates the connection of the Sentry Plus Series unit to a single DUT using the S02 1-meter HV cable set that comes standard with the instrument. The custom white banana plug/red alligator clip is connected between the OUTPUT terminal on the Sentry Plus Series unit and the high side of the device under test. The black banana plug/alligator clip is connected between the RTN/LOW terminal on the Sentry Plus Series unit to the low side of the DUT.

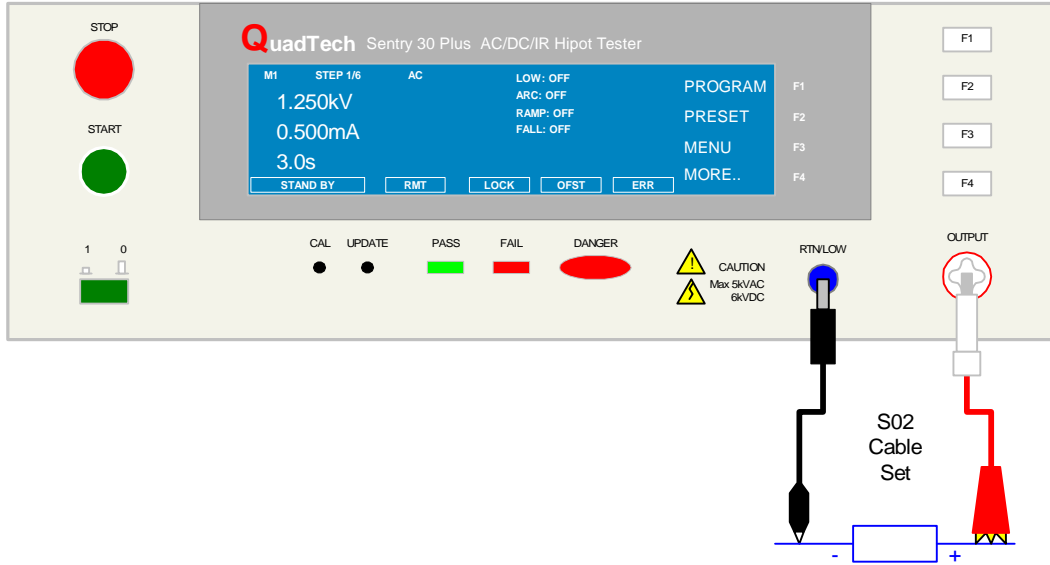

Figure 2-8: S02 Cable Connection

Refer to paragraphs 3.2 through 3.7 for the description and illustration of the connection of several QuadTech accessories to the Sentry Plus Series instrument.

Table 2-4: Accessory/Instrument Connection to Sentry Plus

Accessory/Instrument	Description	Paragraph #	Figure #
S03	Corded Product Adapter	3.4	3-8
S05	Foot Switch	3.5	3-9
S07	Power Entry Adapter	3.3	3-7
S08	Gun Probe	3.6	3-10
Sentry 50 Plus	Ground Bond Tester	3.7	3-11
G16	International Power Strip	3.2	3-6

2.15 Measurement Procedure

Before a measurement is made verify the following:

1. Sentry Plus Series instrument [POWER] ON.
2. 15-minute warm-up.
3. Test parameters programmed and shown on STAND BY display.
4. Test cables or fixture connected.
5. OFFSET Function initiated.
6. Known Good DUT connected & GET Cs function performed.
7. Device under test connected.

The operator has the option of performing a test at power-up conditions (test conditions at which the instrument was last powered down) or recalling one of 60 stored test setups. Refer to paragraphs 2.4 – 2.10 for test programming and storage/recall instructions.

To initiate a test:

- Press [STOP] to make sure instrument is in STAND BY status.
- Press [START]. DANGER led flashes. Status window shows UNDER TEST.
- The test voltage is shut **off** when all test steps are completed,
- **OR** when a test result is judged a FAIL per programmed test limits,
- **OR** when the [STOP] button is pressed.
- Press [STOP] at any time to terminate the output voltage and stop the test.

The Sentry Plus Series instrument judges the measurement value as GOOD or NO GOOD. A GOOD judgment means the DUT passed all programmed steps. Upon completion of the test the output voltage is terminated and the display shows PASS. The rear panel PASS signal is functional and the buzzer sounds (if not turned OFF in SYSTEM parameters under MENU).

If a multiple step test is running and one step in the sequence fails, the Sentry Plus instrument will not continue with the remaining steps

If the measurement value of the test (or any one step of the test) does not meet programmed limits, the DUT is judged as NO GOOD, the display will show FAIL and the buzzer will sound until the [STOP] button is pressed. The [STOP] button may be pressed at any time to terminate the output voltage and stop the test.

NOTE:

When UUUU is shown on the display, the Sentry Plus instrument has exceeded the upper measurement limit for leakage current or insulation resistance.

Error Messages (FAIL result)

When the measurement value was judged NO GOOD and FAIL is shown on the display, an error message denoting the test result will be shown on the display also. Table 2-5 lists the possible error messages for a NO GOOD/FAIL judgment.

Table 2-5: Error Messages

Error Message	Description
HIGH FAIL	Measured value (current or resistance) is over the programmed high limit.
LOW FAIL	Measured value (current or resistance) is below the programmed low limit.
ARC FAIL	Current arc is over the programmed high limit.
I/O FAIL	Hardware Current Limit exceeded. Check DUT for short.
VOLTAGE OVER	Voltage reading is greater than the hardware allowable # of digits.
CURRENT OVER	Current reading is greater than the hardware allowable # of digits.
GFI TRIPPED	Ground Fault Interrupt is No Good.
NO OUTPUT	Output is too Low. (Try increasing test time)
INRUSH FAIL	Charging Current is over limit. (Check test fixture)
MEMORY FULL	Greater than 60 tests/slot have been stored.

2.16 MENU Parameters

With the Sentry Plus Series instrument in STAND BY status, press [F3] = MENU to access programmable instrument parameters. The MENU display contains the Memory, System, Option, Calibration, Key Lock, Change Password, Error Log and About functions. Table 2-6 lists these functions with description and default values.

Table 2-6: MENU Parameters

MENU #	Parameter	Function
1	MEMORY	Store, Recall or Delete a test setup from instrument memory
2	SYSTEM	Change display contrast Change beeper volume Enable EN 50191 Current limit Enable DC 50V AGC Set Pass On Set End of Step
3	OPTION	Multi-Link function, currently unavailable
4	CALIBRATION	Enter instrument calibration routine Qualified service personnel only.
5	KEY LOCK	Lock out front panel program access.
6	CHANGE PASSWORD	Change key lock (user) password.
7	ERROR LOG	View status of error queue.
8	ABOUT	Instrument Information Manufacturer, software version, etc

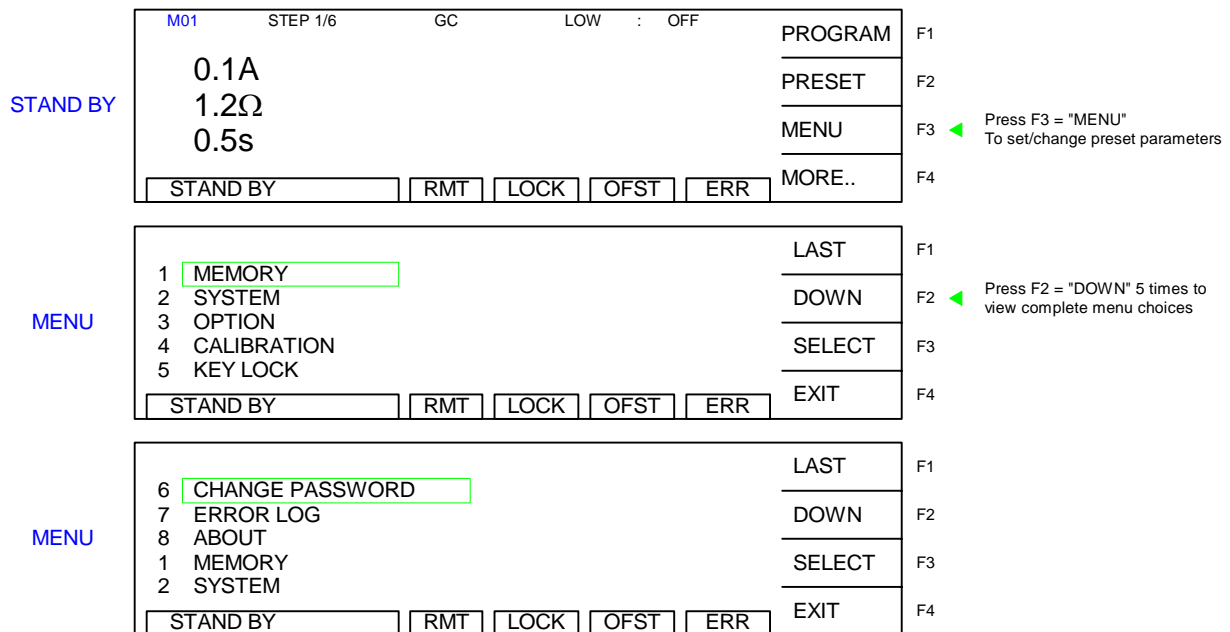

Figure 2-9: Menu Display

2.16.1 MEMORY

Within the MEMORY function is the ability to STORE, RECALL or DELETE test setups, preset parameters and offset values. There are 60 memory locations available and a single location may contain 1-10 steps. The total memory array is 60 and the instrument uses up to 10 locations to run the test(s). If a 3-step test is programmed then the instrument uses 3 additional steps to run the test. Therefore five 10-step sequences, fifty-nine 1-step sequences or a combination therein could be programmed. If more than 50 locations are stored, then the Sentry Plus will prompt “memory full” when the store function is accessed again.

MENU	1	MEMORY	LAST	F1	◀	To move to #8, About.
	2	SYSTEM	DOWN	F2	◀	To toggle through MENU functions.
	3	OPTION	SELECT	F3	◀	To enter MEMORY function.
	4	CALIBRATION	EXIT	F4	◀	Return to STAND BY display.
	5	KEY LOCK				
		SELECT FUNC.	RMT	LOCK	OFST	ERR
MEMORY	1	(0 STEPS)	STORE	F1	◀	To store a test setup in memory location 1-60
	2	(0 STEPS)	RECALL	F2	◀	Recall test in highlighted location.
	3	(0 STEPS)	DELETE	F3	◀	Delete test in highlighted location.
	4	(0 STEPS)	RETURN	F4	◀	Return to MENU display.
	5	(0 STEPS)				
		SELECT FUNC.	RMT	LOCK	OFST	ERR
Select LOCATION	1	(0 STEPS)	LAST	F1	◀	To move highlighted box to memory location 60
	2	(0 STEPS)	DOWN	F2	◀	To toggle through memory locations 1-60
	3	(0 STEPS)	SELECT	F3	◀	To select highlighted memory location and store previously programmed test setup
	4	(0 STEPS)	RETURN	F4		
	5	(0 STEPS)				
		SEL. MEMORY	RMT	LOCK	OFST	ERR
LABEL	1	(0 STEPS) 123	UP	F1	◀	
	2	(0 STEPS)	DOWN	F2	◀	
	3	(0 STEPS)	NEXT C.	F3	◀	Press 2 Times to exit LABEL function
	4	(0 STEPS)	CANCEL	F4		
	5	(0 STEPS)				
		SEL. MEMORY	RMT	LOCK	OFST	ERR
Confirm STORE	1	(0 STEPS)	YES	F1	◀	Store test setup to location #1
	2	(0 STEPS)	NO	F2		
	3	(0)		F3		
	4	(0) STORE TO 1?		F4		
	5	(0)				
			RMT	LOCK	OFST	ERR
MEMORY	1	(6 STEPS) 123	STORE	F1		
	2	(0 STEPS)	RECALL	F2		
	3	(0 STEPS)	DELETE	F3		
	4	(0 STEPS)	RETURN	F4	◀	Return to MENU display.
	5	(0 STEPS)				
		SELECT FUNC.	RMT	LOCK	OFST	ERR

Figure 2-10: Memory Function

To Recall a Test Setup:

With the Sentry Plus instrument in Stand By status:

Press [F3] = MENU.

Press [F3] = SELECT to select **MEMORY** from the menu parameters list.

Press [F2] = RECALL to select the recall function.

Press [F1] = LAST or [F2] = DOWN to toggle through the test steps.

When the highlighted box is around the test step you want (3. **3 steps**),

Press [F3] = SELECT.

The Sentry Plus instrument will prompt: "Recall From 3?"

Press [F1] = YES to recall the test setup or [F2] = NO to select another test setup.

Press [F4] = RETURN to go back to the MENU display.

Press [F4] = EXIT to return the instrument to STAND BY status.

When the Sentry Plus has Key Lock turned ON, the user has the option to lock out recall or allow for programs to be recalled. If Recall is allowed when Key Lock is ON, then the Recall function is accessible from the Stand By Menu. This lets the operator recall a memory location without having to navigate through the menu system.

STAND BY	M01	1/5	GC	LOW	: 0.3Ω	KEY LOCK	F1	◁	To change Key Lock Status to OFF
	0.1A					RECALL	F2	◁	To recall test setup from Memory
	1.2Ω					MENU	F3		
	0.5s					MORE..	F4		
	STAND BY	RMT	LOCK	OFST	ERR				

To Recall with Key Lock ON in STAND BY status:

Press [F2] = RECALL

Press [F1] = LAST or [F2] = DOWN to toggle through test setups.

When the desired test setup is **highlighted** (backlit):

Press [F3] = SELECT and you will automatically return to STAND BY status.

To DELETE a Test Setup:

With the Sentry Plus instrument in Stand By status:

Press [F3] = MENU.

Press [F3] = SELECT to select **MEMORY** from the menu parameters list.

Press [F3] = DELETE to select the delete function.

Press [F1] = LAST or [F2] = DOWN to toggle through the test steps.

When the highlighted box is around the test step you want (3. **3 steps**),

Press [F3] = SELECT.

The Sentry Plus instrument will prompt: "Delete From 3?"

Press [F1] = YES to delete the test setup or [F2] = NO to select another test setup.

Press [F4] = RETURN to go back to the MENU display.

Press [F4] = EXIT to return the instrument to STAND BY status.

2.16.2 SYSTEM

Within the SYSTEM function are four programmable parameters: Contrast, Beeper Volume, EN50191 and DC 50V AGC. With the instrument in Stand By status, access these system parameters by pressing [F3] = MENU. Press [F2] = DOWN to move the highlighted box to **SYSTEM**.

STAND BY

M01 STEP 1/6 GC LOW : 0.30 PROGRAM F1
 0.1A PRESET F2
 1.2Ω MENU F3 ← Press F3 = "MENU" To change instrument parameters
 0.5s MORE.. F4
 STAND BY RMT LOCK OFST ERR

MENU

1 MEMORY LAST F1
 2 SYSTEM DOWN F2 ← Press F2 = "DOWN" to move highlighted box to SYSTEM
 3 OPTION SELECT F3 ← Press F3 = "SELECT" to enter SYSTEM parameters
 4 CALIBRATION EXIT F4
 5 KEY LOCK
 SELECT FUNC. RMT LOCK OFST ERR

SYSTEM

1 CONTRAST : 15 INC. F1 ← Press F1 = "INC." to increase brightness of display
 2 BUZZER VOLUME : OFF DEC. F2 ← Press F2 = "DEC." to decrease brightness of display
 3 EN 50191 : OFF NEXT F3 ← Press F3 = "NEXT" to move highlighted box to Buzzer Volume
 4 DC 50V AGC : ON RETURN F4 ← Press F4 = "RETURN" to go back to MENU display
 5 PASS ON : OFF
 6 END OF STEP : OFF
 1 - 15 RMT LOCK OFST ERR

2.16.2.1 CONTRAST

The CONTRAST parameter adjusts the brightness of the LCD display. The range is 1-15 with 15 being the brightest and 1 being the darkest. The initial default setting is 7.

2.16.2.2 BEEPER VOLUME

The BEEPER VOLUME can be adjusted from L (low) to M (medium) to H (high, loud) or it can be turned OFF. The initial default setting is H (a loud pitch).

2.16.2.3 EN50191

The EN50191 function sets the maximum leakage current at 3mA AC or 5mA DC in accordance with the European standard. When EN50191 is ON, the Sentry Plus Series instrument will terminate the voltage at the output terminals when the leakage current exceeds 3mA AC or 5mA DC. The EN 50191 function can be set ON or OFF and the initial setting is OFF.

EN50191 (The Erection and Operation of Electrical Test Installations) specifies safety guidelines for both the test equipment and stations used in production lines, laboratories, test houses and other test environments. The 3mA AC/5mA DC leakage current limit is just one electrical safety measure in attempting to specify 'full protection from live parts' for the operator and the DUT.

2.16.2.4 DC 50V AGC

The Automatic Gain Control (AGC) circuit is used to keep the output signal of a circuit constant as the amplitude of the input signal varies. So when the DC 50V AGC function is ON, the output voltage is held constant at 50V for a DC hipot test. The DC 50V AGC function can be set ON or OFF and the initial default setting is ON. This applies to a programmed voltage of 50V only.

NOTE:

Only in highly specialized applications should the DC 50V AGC function be set to OFF. The default value is ON because in normal test modes, it is necessary to keep the output signal constant as the amplitude of the input signal varies to obtain stable results.

2.16.2.5 PASS ON

The Pass On setting (On/Off) provides the option of programming the time during which a pass relay is closed after a pass condition at the completion of the test.

2.16.2.6 END OF STEP

End of Step (On/Off) is a 10 msec signal notifying the PLC that a Step has ended.

2.16.3 OPTION

Within the OPTION function is the multi-link parameter. The multi-link function is not available in the current software version. This option may be available in future software updates.

2.16.4 CALIBRATION

The CALIBRATION function requires a password to enter the instrument routine. Only qualified service personnel with NIST traceable standards should perform instrument calibration. Refer to paragraph 4.3 for the full Sentry Plus Series calibration procedure.

2.16.5 KEY LOCK

To lock out the PROGRAM, PRESET and MENU functions of the Sentry Plus Series instrument use the KEY LOCK function in the MENU parameters. The initial instrument setting is OFF. To activate the KEY LOCK function with the instrument in STAND BY status:

- Press [F3] = MENU
- Press [F2] = DOWN until KEY LOCK is backlit.
- Press [F3] = SELECT

STAND BY	M01	STEP 1/6	GC	LOW	: 0.3Ω	PROGRAM	F1
	0.1A					PRESET	F2
	1.2Ω					MENU	F3
	0.5s					MORE..	F4
	STAND BY	RMT	LOCK	OFST	ERR		
MENU	1	MEMORY				UP	F1
	2	SYSTEM				DOWN	F2
	3	OPTION				SELECT	F3
	4	CALIBRATION				EXIT	F4
	5	KEY LOCK					
	SELECT FUNC.	RMT	LOCK	OFST	ERR		

Press F3 = "MENU"
To change instrument parameters

Press F2 = "DOWN" to move highlighted box to KEY LOCK

Press F3 = "SELECT" to enter KEY LOCK function

- Display prompts 'USER PASSWORD'
- Press [A] [A] [A] [A] [ENTER]
- **NOTE: AAAA is the default password. If password has been changed use the new password.**

KEYLOCK	KEY LOCK	A	F1			
	USER PASSWORD : <input type="text" value="xxxx"/>	B	F2			
		ENTER	F3			
		RETURN	F4			
	1 - 10 CHAR.	RMT	LOCK	OFST	ERR	

Press F1 = "A" to input password character

Press F2 = "B" to input password character

Press F3 = "ENTER" to enter whole password

Press F4 = "RETURN" to go back to MENU display

- Display prompts 'RECALL LOCK?'
- **NOTE: This means: "Do you want to lock out the ability to recall memory locations?"**
- Press [F1] = YES to select KEY LOCK ON.
- **NOTE: Selecting YES disallows the recalling of programmed tests from memory.**
- The **LOCK** block at bottom of display is backlit.

KEYLOCK	KEY LOCK ON!	YES	F1				
	RECALL LOCK?	NO	F2				
			F3				
		CANCEL	F4				
	YES / NO	RMT	LOCK	OFST	ERR		
MENU						UP	F1
	1	MEMORY				DOWN	F2
	2	SYSTEM				SELECT	F3
	3	OPTION				EXIT	F4
	4	CALIBRATION					
5	KEYLOCK						
	SELECT FUNC.	RMT	LOCK	OFST	ERR		

Press F1 = "YES" to turn ON key lock function

Press F2 = "NO" to turn OFF key lock function

Press F4 = "CANCEL" to go back to MENU display

Press F4 = "EXIT" to go back to STAND BY display

- Press [F4] = EXIT to return to STAND BY status.

STAND BY	M01	1/6	GC	LOW	: 0.3Ω	KEY LOCK	F1 <	To change Key Lock Status to OFF
	0.1A					RECALL	F2 <	To recall test setup from Memory
	1.2Ω					MENU	F3	
	0.5s					MORE..	F4	
	STAND BY	RMT	LOCK	OFST	ERR			

To disable the KEY LOCK function, repeat above steps (note: there is no confirmation page “Recall Lock?”).

2.16.6 CHANGE PASSWORD

The Sentry Plus Series instruments have a password function for locking out the front panel so that the instrument PRESET settings and PROGRAM function are disabled. The CHANGE PASSWORD function applies to the initial instrument password. The password is comprised of “A” or “B” characters and can be 1-10 characters in length. To activate the CHANGE PASSWORD function with the instrument in STAND BY status:

- Press [F3] = MENU
- Press [F2] = DOWN until **CHANGE PASSWORD** is backlit.
- Press [F3] = SELECT

STAND BY	M01	STEP 1/6	GC	LOW	: 0.3Ω	PROGRAM	F1	
	0.1A					PRESET	F2	
	1.2Ω					MENU	F3	Press F3 = "MENU" To change instrument parameters
	0.5s					MORE..	F4	
	STAND BY	RMT	LOCK	OFST	ERR			

MENU						UP	F1	
	1	MEMORY				DOWN	F2	Press F2 = "DOWN" to move highlighted box to PASSWORD
	2	SYSTEM				SELECT	F3	
	3	OPTION				EXIT	F4	
	4	CALIBRATION						
	SELECT FUNC.	RMT	LOCK	OFST	ERR			

MENU						UP	F1	
	6	PASSWORD				DOWN	F2	
	7	ERROR LOG				SELECT	F3	Press F3 = "SELECT" to enter PASSWORD function
	8	ABOUT				EXIT	F4	
	1	MEMORY						
	SELECT FUNC.	RMT	LOCK	OFST	ERR			

- Display prompts ‘ USER PASSWORD’
- Press [A] [A] [A] [A] [ENTER]

PASSWORD	CHANGE PASSWORD	A	F1 <	Press F1 = "A" to input password character
	USER PASSWORD : <input type="text" value="XXXX"/>	B	F2 <	Press F2 = "B" to input password character
		ENTER	F3 <	Press F3 = "ENTER" to enter whole password
	1 - 10 CHAR. RMT LOCK OFST ERR	RETURN	F4 <	Press F4 = "RETURN" to go back to MENU display

- Display prompts 'NEW PASSWORD'
- Press [B] [B] [B] [B] [ENTER]
- Display prompts 'CONFIRM'
- Press [B] [B] [B] [B] [ENTER]
- Display prompts 'CHANGE PASSWORD OK'.

PASSWORD	CHANGE PASSWORD	A	F1 <	Press F1 = "A" to input password character
	NEW PASSWORD : <input type="text" value="XXXX"/>	B	F2 <	Press F2 = "B" to input password character
		ENTER	F3 <	Press F3 = "ENTER" to enter whole password
	1 - 10 CHAR. RMT LOCK OFST ERR		F4	

PASSWORD	CHANGE PASSWORD	A	F1 <	Press F1 = "A" to input password character
	CONFIRM : <input type="text" value="XXXX"/>	B	F2 <	Press F2 = "B" to input password character
		ENTER	F3 <	Press F3 = "ENTER" to enter whole password
	1 - 10 CHAR. RMT LOCK OFST ERR		F4	

PASSWORD	CHANGE PASSWORD OK!		F1	
			F2	
			F3	
		RETURN	F4 <	Press F4 = "RETURN" to go back to MENU display

- Press [F4] = RETURN to exit password function and return to MENU display.
- Press [F4] = EXIT to go to STAND BY display.

2.16.7 ERROR LOG

The Sentry Plus Series instruments have an Error Log to track invalid remote commands. This function is currently unavailable. The Error Log lists the code and description of each error. To view the contents of the queue:

- Press [F3] = MENU
- Press [F2] = DOWN until **ERROR LOG** is backlit.
- Press [F3] = SELECT
- Display lists the contents of the ERROR LOG.

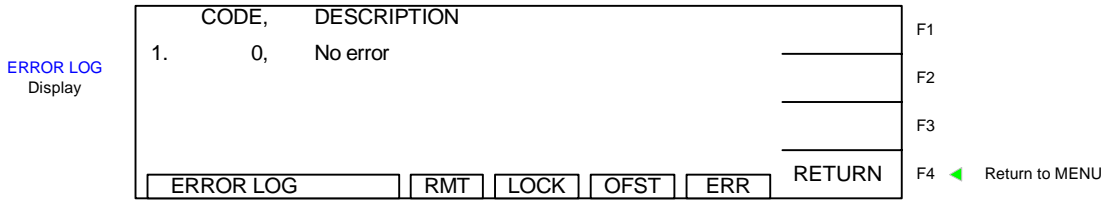

Figure 2-11: Error Log

2.16.8 ABOUT

The Sentry Plus Series instruments have a parameter labeled ‘About’. This parameter lists the instrument manufacturer, software version and date. To view the contents of ABOUT with the instrument in STAND BY status:

- Press [F3] = MENU
- Press [F2] = DOWN until **ABOUT** is backlit.
- Press [F3] = SELECT
- Display lists the contents of ABOUT.

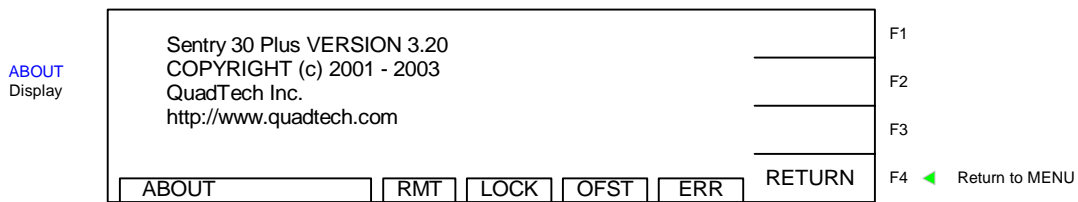

Figure 2-12: ABOUT Display

Section 3: Interface

3.1 Remote

A 9-pin D-Series remote control connector is located on the rear panel of the Sentry Plus Series instrument. There is a black 5 screw terminal strip for the remote input signals: START, RESET, COM and INTERLOCK. Inputs require a contact closure. Figure 3-1 illustrates the Remote terminal strip connector and 9-pin D-Series connector.

Before connecting the instrument to its power source, the interlock function on the rear panel remote connector (terminal strip) must be properly utilized. This is an important safety feature for the protection of the operator. When the INTERLOCK jumper is removed, there is **no** high voltage at the OUTPUT. Therefore, to initiate a test make sure the interlock jumper is in place.

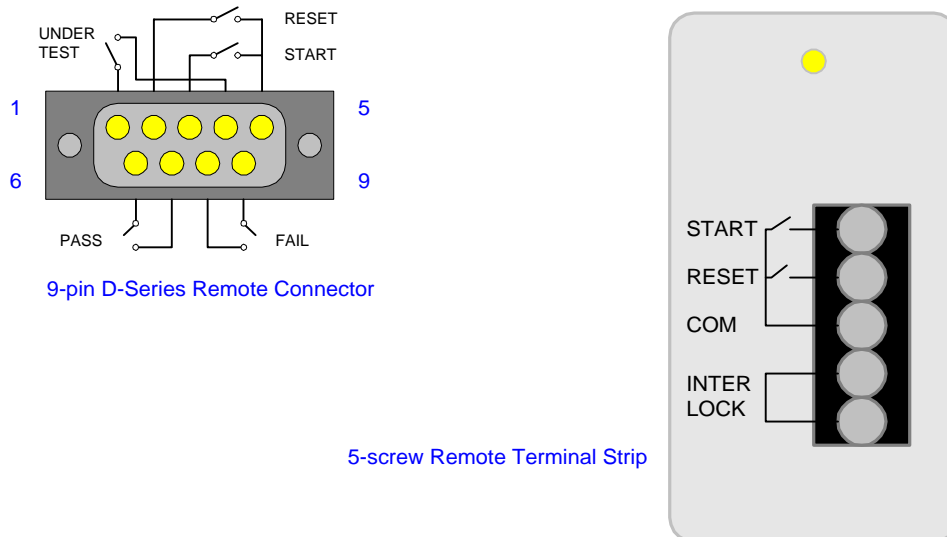

Figure 3-1: Sentry Plus Series Remote Connectors

The Sentry Plus Series instrument has three output signals on the rear panel. The UNDER TEST relay is closed during a test. The PASS relay is closed when the DUT is judged GOOD. The FAIL relay is closed when the DUT is judged NO GOOD. These relays are rated for voltage up to 115VAC and current <100mA.

Figures 3-2 and 3-3 illustrate possible remote control connections to the Sentry Plus Series terminal strip. Use extreme care when using a remote control connection as the High Voltage Output is being turned ON and OFF with an external signal.

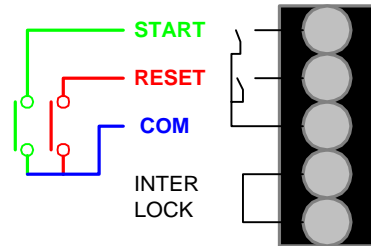

Figure 3-2: Single Control of START or RESET

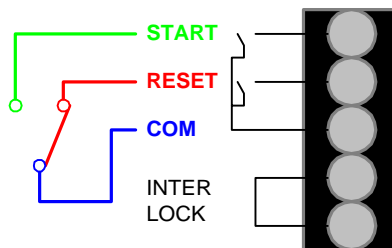

Figure 3-3: Continuous Control of RESET

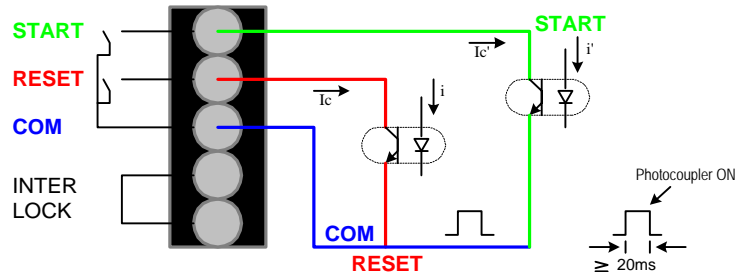

Figure 3-4: Logic Components as Control Circuit

Figure 3-4 illustrates the usage of logic components (transistor, FET or couplers) as a control circuit. To use this system to control the circuit, the low signal current must be $\leq 2\text{mA}$ and the input signal's active time must be $> 20\text{ms}$. The relay switch in Figure 3-2 or the coupler control in Figure 3-4 uses the component's contact for the control action, not both. This can effectively prevent operation interference however be observant of interference induced by measurement settings.

START and RESET terminals have unregulated 24VDC present. To initiate a test connect the START and COM terminals. The input time duration is approximately 20milliseconds. The above input circuits are not isolated from other internal circuits. To terminate a test connect the RESET and COM terminals.

Figure 3-5 illustrates the timing diagram for the Sentry Plus Series instruments under a PASS condition and a FAIL condition.

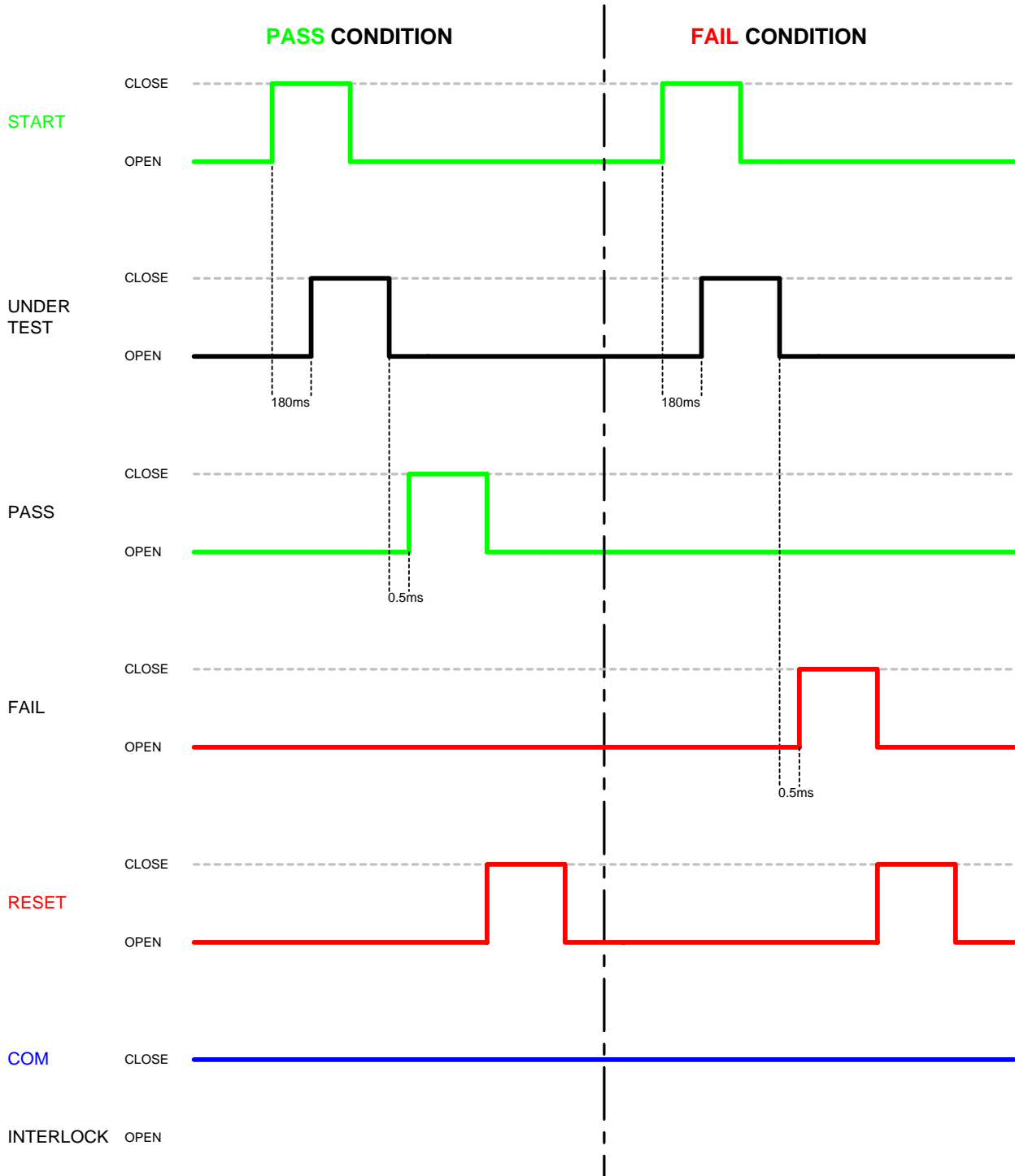

Figure 3-5: Sentry Plus Series Timing Diagram

3.2 G16 International Power Strip

The Sentry Plus Series instruments can be connected to the G16 International Power Strip as illustrated in Figure 3-6 for safety testing of many European corded products.

- | | | |
|----------------|-----------------|--------------|
| *Australia | *United Kingdom | *Denmark |
| *North America | *Norway | *Finland |
| *Sweden | *Germany | *Netherlands |
| *Austria | *Switzerland | *Italy |

1. Connect the three G-16 ground connectors to the Sentry Plus RTN/LOW terminal.
2. Note: there is a second RTN/LOW terminal on the rear of the Sentry instrument.
3. Connect the white banana plug to the Sentry Plus OUTPUT terminal.
4. Plug DUT's AC power cord into corresponding module on G16 power strip.

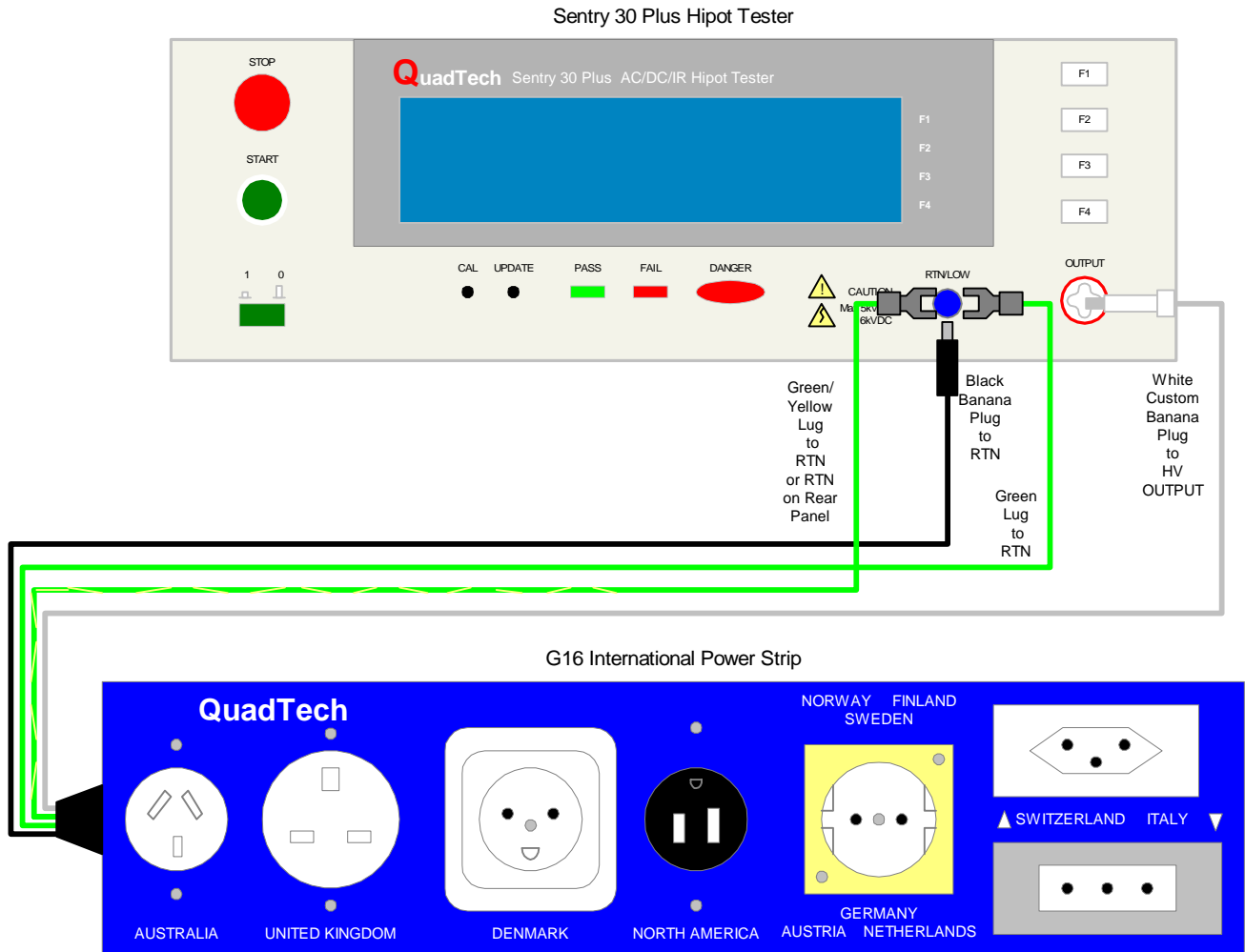

Figure 3-6: G16 International Power Strip Connection to Sentry 30 Plus

3.3 S07 Power Entry Adapter Cable

The S07 Power Entry Adapter Cable is a 3-wire AC inlet receptacle for precise testing of corded products. The S07 cable is connected to the Sentry Plus Series instrument via a two-lead set.

1. Remove DUT's power cord from its AC inlet module.
2. Plug S07 Power entry adapter into DUT's AC inlet module.
3. Connect the white custom banana plug to the Sentry Plus OUTPUT terminal. Connect black banana plug with retaining bracket to the Sentry Plus RTN/LOW terminal.
4. For GC test, connect GC Lead (700100) to rear Sentry Cont Check terminal and metal on case of DUT.

Figure 3-7 illustrates this connection of the S07 cable to a Sentry 30 Plus instrument.

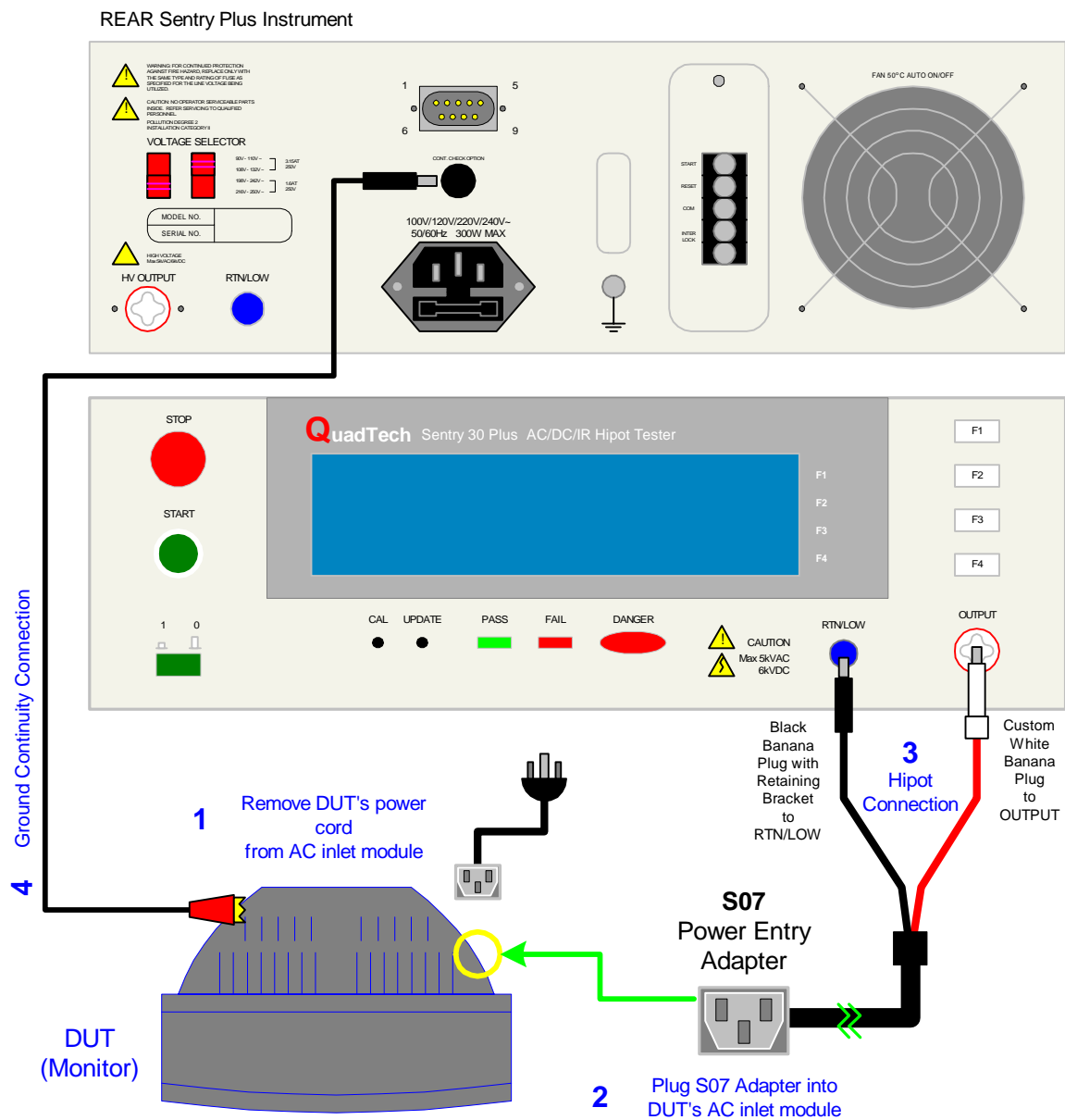

Figure 3-7: S07 Power Entry Adapter Cable

3.4 S03 Corded Product Adapter (115V)

The S03 Corded Product Adapter is a 3-prong electrical outlet box to facilitate testing of corded products. The S03 cable is connected to the Sentry Plus Series instrument via a two-lead set.

1. Connect the black banana plug to the Sentry Plus RTN/LOW.
2. Connect the white banana plug to the Sentry Plus OUTPUT terminal.
3. Plug the DUT's 3-wire power cord into the S03 corded product adapter.
4. For GC test, connect GC Lead (700100) to rear Sentry Cont Check terminal and metal on case of DUT.

Figure 3-8 illustrates this connection of the S03 cable to a Sentry 30 Plus instrument.

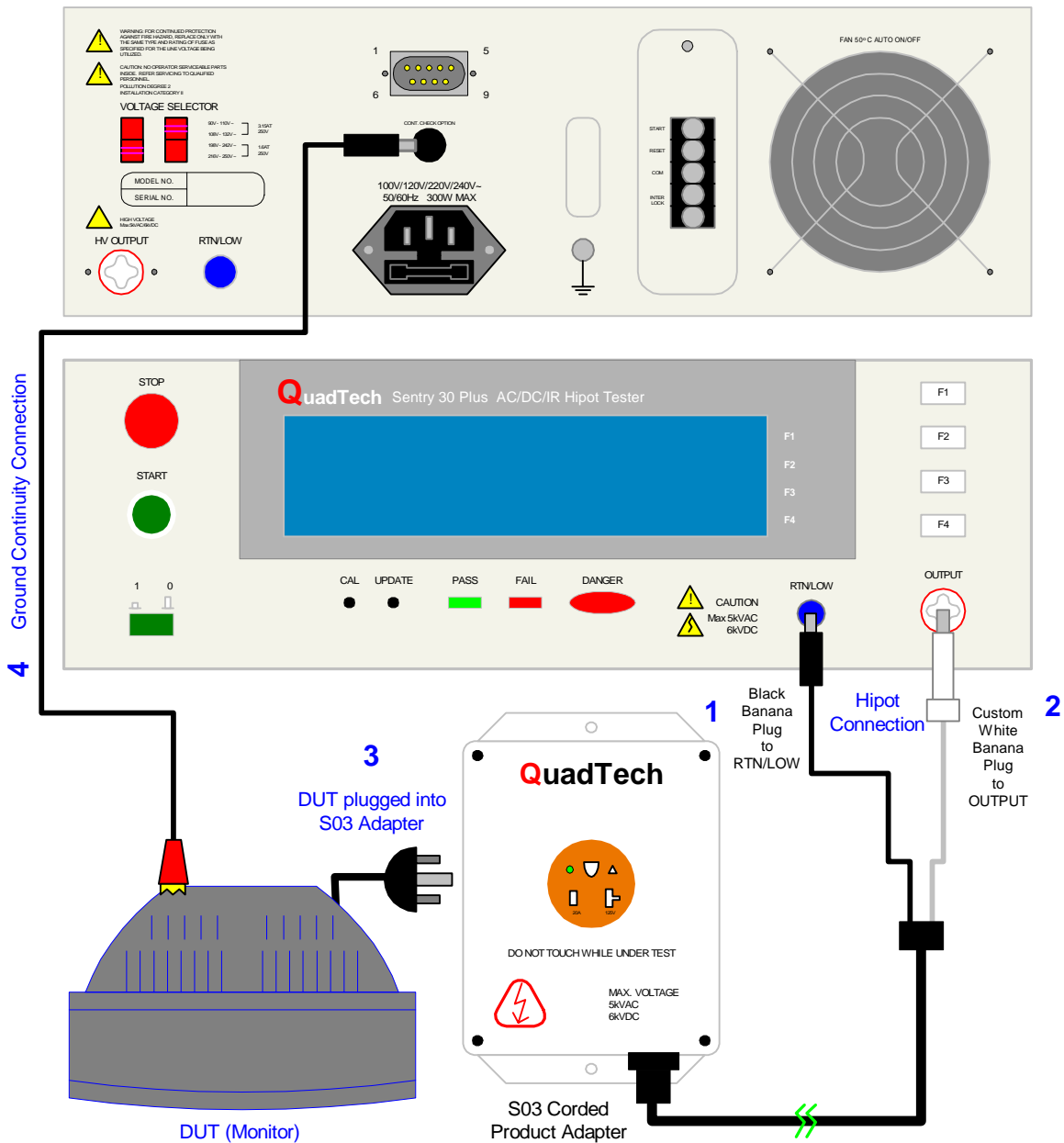

Figure 3-8: S03 Corded Product Adapter

3.5 S05 Foot Switch

The S05 Foot Switch provides hands-free remote testing capability. The spade leads on the S05 Foot Switch are connected (screwed) to the terminal strip on the rear panel of the Sentry Plus Series instrument.

1. Connect (screw) the white wire/spade connector to the START terminal.
2. Connect (screw) the red wire/spade connector to the COM terminal.

Figure 3-9 illustrates this connection of the S05 Foot Switch to a Sentry 30 Plus instrument.

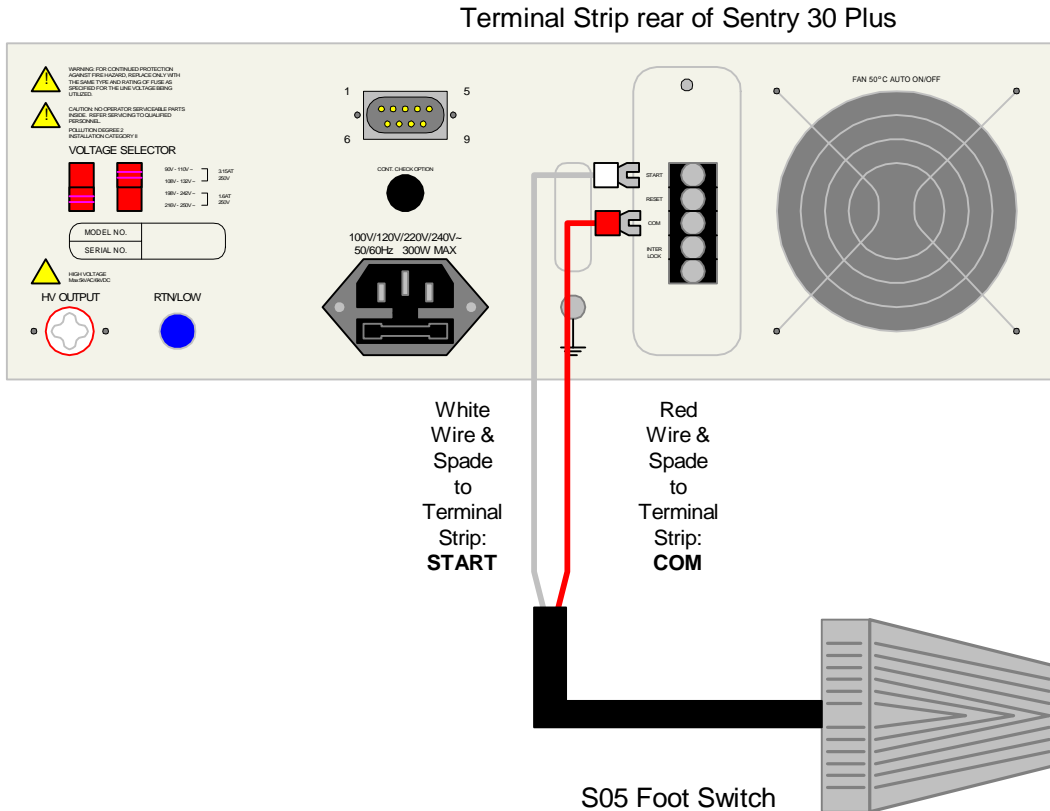

Figure 3-9: S05 Foot Switch

3.6 S08 Gun Probe

The S08 Gun Probe provides fast testing capability with pinpoint control. Use the black lead of the S02 Lead Set with the S08 Gun Probe.

1. Connect the S02 black banana plug to the Sentry Plus RTN/LOW terminal.
2. Connect the S02 black alligator clip to the low side of the DUT.
3. Connect the white banana plug to the Sentry Plus OUTPUT terminal.

Figure 3-10 illustrates this connection of the S08 probe to a Sentry 30 Plus unit.

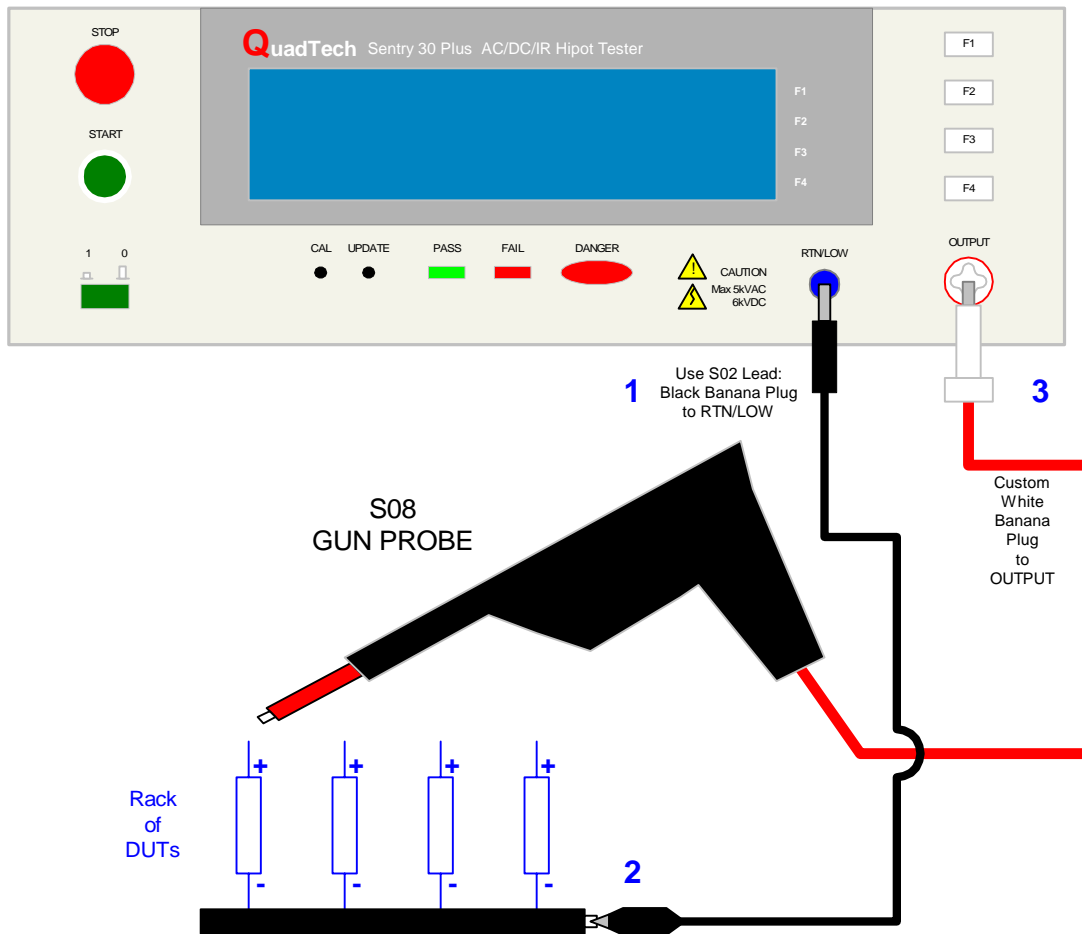

Figure 3-10: S08 Gun Probe connected to Sentry 30 Plus Hipot Tester

3.7 S50 Plus Ground Bond Tester

The Sentry Plus Series instrument can be connected to the Sentry 50 Plus Ground Bond Tester for high current ground testing between chassis and power cord ground. The output current is programmable from 1A to 30A AC in 0.01A increments and resistance can be measured over the range 0.1mΩ to 510mΩ. The rear panels of the Sentry Plus Series instrument and Sentry 50 Plus instrument are connected via the S15 9-pin interconnection cable. Figure 3-11 illustrates the front panel connections of the two instruments. [NOTE: GFI must be turned OFF on the Sentry Plus unit when it is used with the Sentry 50 Plus instrument.](#)

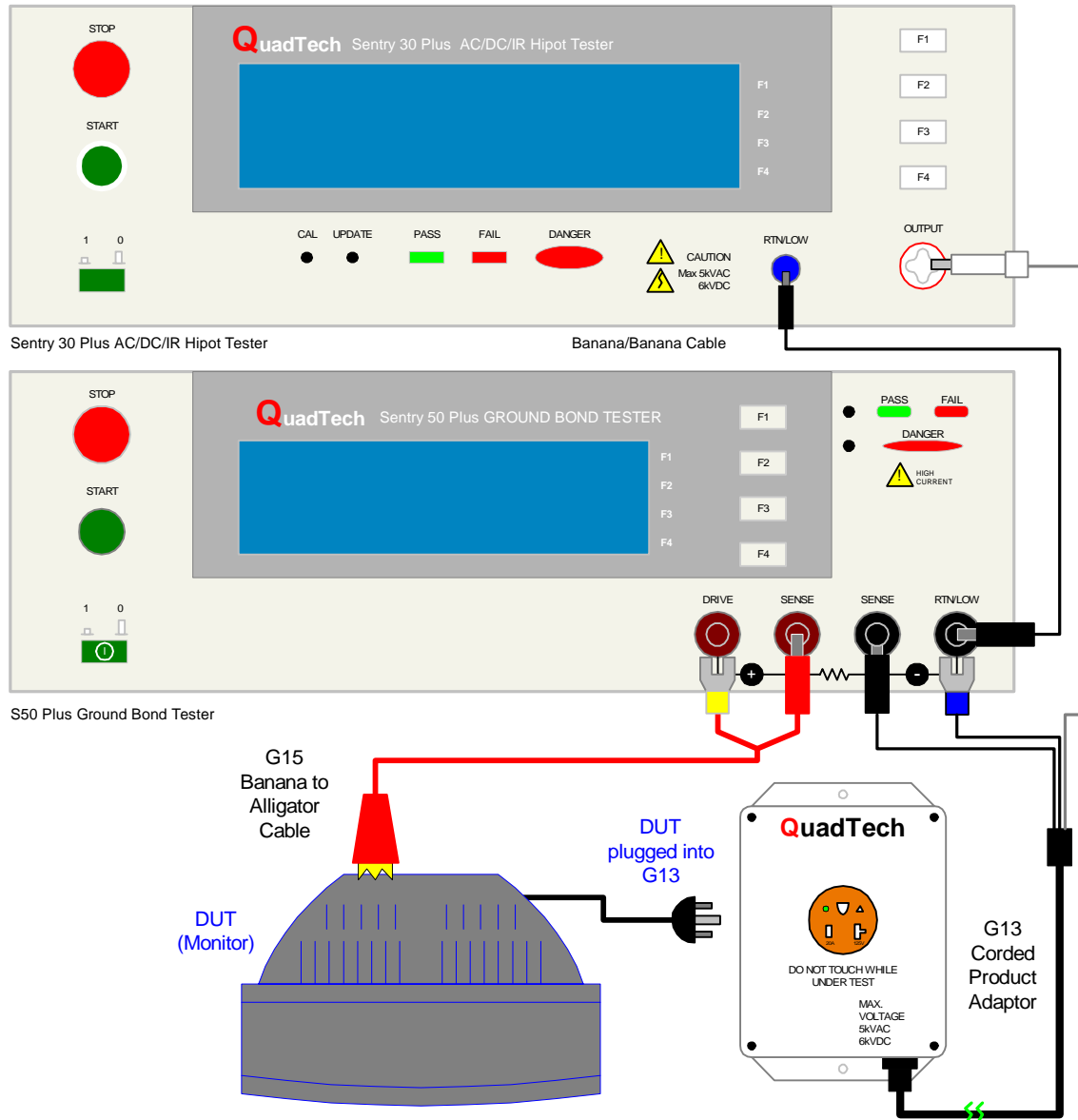

Figure 3-11: Guardian 1030S & Sentry 50 Plus Connection

Section 4: Service & Calibration

4.1 General

Our warranty (at the front of this manual) attests to the quality of materials and workmanship in our products. If malfunction should be suspected, or other information desired, applications engineers are available for technical assistance. Applications assistance is available in the U.S. by calling (978) 461-2100 and asking for Applications Support. For support outside of the United States please contact your local QuadTech Distributor. [Service/Calibration](#) and [Distributor](#) information is also available online.

4.2 Instrument Return

Before returning an instrument to QuadTech for service please call our **Customer Care Center (CCC)** at **800-253-1230** for Return Material Authorization (RMA). It will be necessary to include a Purchase Order Number to insure expedient processing, although units found to be in warranty will be repaired at no-charge. For any questions on repair costs or shipping instructions please contact our CCC Department at the afore-mentioned number. To safeguard an instrument during storage and shipping, please use packaging that is adequate to protect it from damage, i.e. equivalent to the original packaging, and mark the box “Delicate Electronic Instrument”. Return material should be sent freight prepaid to:

[QuadTech, Inc.](#)
[5 Clock Tower Place, 210 East](#)
[Maynard, Massachusetts 01754](#)

[Attention: RMA#](#)

[Shipments sent collect cannot be accepted.](#)

4.3 Calibration

Calibration of the Sentry Plus Series instruments is recommended on an annual basis. If the unit is returned to QuadTech for factory calibration, refer to paragraph 4.2 for RMA and shipping instructions. Using the calibration procedure in paragraph 4.3.1, the Sentry Plus Series instrument may be calibrated by a qualified service person IF traceable calibration equipment and standards are available. **The instrument should be powered up for a minimum of 30 minutes prior to calibration to ensure maximum stability.**

Table 4-1: Calibration Equipment

Equipment	Requirements	Equipment	Requirements
AC/DC High Voltage Voltmeter	Measure: 0 to 6kV, 0.1% accuracy	250kΩ Res. Std	1200V, 5mA, 5W; 1250V 7mA
AC/DC Current Meter	Measure: 0 to 40mA, 0.1% accuracy	100kΩ Res. Std	400V, 4mA, 50W; 1200V 12mA
1GΩ Resistance Standard	250V	80kΩ Res. Std	1200V, 15mA, 100W
100MΩ Resistance Standard	500V	1Ω Resistor	0.1A
10MΩ Resistance Standard	1200V, 0.12mA, 0.25W; 500V; 1kV	3Ω Resistor	0.1A
500kΩ Resistance Standard	1200V, 2.4mA, 0.25W		

4.3.1 Calibration Parameters

Table 4-2 contains the calibration parameters for the Sentry Plus Series instruments. All tests points are not required for each of the instruments (10 Plus, 20 Plus & 30 Plus).

Table 4-2: Calibration Parameters

Product	TEST		Range	CAL. POINT	
Voltage Calibration					
10/20/30	CAL	ACV	5kV	OFST	0.050kV
10/20/30	CAL	ACV	5kV	FULL	4.000kV
20/30	CAL	DCV	6kV	OFST	0.050kV
20/30	CAL	DCV	6kV	FULL	4.000kV
30	CAL	IR	1kV	OFST	0.050kV
30	CAL	IR	1kV	FULL	1.000kV
Current Calibration					
10/20/30	CAL	ACA	3mA	OFST	0.12mA / 10MΩ
10/20/30	CAL	ACA	3mA	FULL	2.4mA / 500kΩ
10/20/30	CAL	ACA	15mA	OFST	2.4mA / 500kΩ
10/20/30	CAL	ACA	15mA	FULL	12mA / 100kΩ
20/30	CAL	DCA	3mA	OFST	0.12mA / 10MΩ
20/30	CAL	DCA	3mA	FULL	2.4mA / 500kΩ
20/30	CAL	DCA	5mA	OFST	2.4mA / 500kΩ
20/30	CAL	DCA	5mA	FULL	4.8mA / 250kΩ
WAC & WDC Arcing Calibration					
10/20/30	CAL	AC ARC	15mA	Arc	7.00mA
20/30	CAL	DC ARC	5mA	Arc	5.00mA
IR Resistance Calibration					
30	CAL	IRR Range1	1000MΩ	Range 1	1000M = 1.00GΩ
30	CAL	IRR Range2	100MΩ	Range 2	100.0MΩ
30	CAL	IRR Range3	10MΩ	Range 3	10.0MΩ
30	CAL	IRR Range4	10MΩ	Range 4	10.0MΩ

Ground Continuity Calibration					
10/20/30	CAL	GC	1Ω	OFST	1Ω
10/20/30	CAL	GC	3Ω	FULL	3Ω
Contrast Calibration					
10/20/30	CAL	CONTRAST	11	11	13

4.3.2 Enable Calibration

The instrument should be powered up for a minimum of 30 minutes prior to calibration to ensure maximum stability. With the Sentry Plus Series instrument in standby status ([STOP] button previously pressed and no warning lights flashing) remove the Calibration seal over the hole labeled “CAL” on the front panel and push the recessed switch to the IN position.

The unit is in STAND BY status.

Press [F3] = MENU.

Press [F2] = DOWN three times until **CALIBRATION** is highlighted (backlit).

Press [F3] = SELECT to choose calibration function.

Display will prompt for a password.

Press [A] [A] [A] [B] [ENTER]

STAND BY

M01 STEP 1/6 GC LOW : OFF PROGRAM

0.1A PRESET

1.2Ω MENU

0.5s MORE..

STAND BY RMT LOCK OFST ERR

F1
F2
F3 ◀ Press F3 = "MENU" To change instrument parameters
F4

MENU

1 MEMORY UP

2 SYSTEM DOWN

3 OPTION SELECT

4 CALIBRATION

5 KEY LOCK EXIT

SELECT FUNC. RMT LOCK OFST ERR

F1
F2 ◀ Press F2 = "DOWN" to move highlighted box to CALIBRATION
F3 ◀ Press F3 = "SELECT" to enter CAL parameters
F4

CALIBRATION

CALIBRATION A

CAL. PASSWORD : B

1 - 10 CHAR. RMT LOCK OFST ERR RETURN

F1 ◀ Press F1 = "A" to enter character of password
F2 ◀ Press F2 = "B" to enter character of password
F3
F4 ◀ Press F4 = "RETURN" to go back to MENU display

Cal Step 1: ‘ACV 5kV Offset (50V)’ is displayed on the screen.

NOTE

The ‘Calibration is OFF’ display may occur if the CAL recessed switch has **not** been pressed IN prior to entering Calibration function.

NOTE:

When in the Calibration Routine:

- Pressing [UP] or [DOWN] scrolls through the calibration steps.
- Pressing [START] initiates the calibration of the particular step
- Pressing [INC.] or [DEC.] adjusts the Standard Value
- Pressing [ENTER] accepts the calibration value.
- Pressing [STOP] completes calibration of the particular step.

4.3.3 AC Voltage Calibration

Connect the OUTPUT terminal of the Sentry Plus Series unit to the input terminal of the AC/DC high voltage meter. Connect the RTN/LOW terminal of the Sentry Plus to the GND terminal of the voltmeter. Set the voltmeter to AC and 2kV range.

Cal Step 1: 'ACV 5kV Offset (50V)'

Press [STOP] to return instrument to steady state.

Press [START] to get offset value.

Press [F1] = INC or [F2] = DEC until the Sentry Plus display reads the same as the voltmeter.

Press [ENTER] to accept reading.

Sentry Plus reverts to "ACV Offset" display (incorporating new cal value).

Press [F1] = UP to go to **Cal Step 2: 'ACV 5kV Full (4kV)'**. Change voltmeter range to 20kV.

Press [STOP] to return instrument to steady state.

Press [START] to get full value

Press [F1] = INC or [F2] = DEC until the Sentry Plus display reads the same as the voltmeter.

Press [ENTER] to accept reading.

Sentry Plus reverts to "ACV Full" display (incorporating new cal value).

4.3.4 DC Voltage Calibration (DCV)

Change the setting on the Valhalla voltmeter to DC and 2kV range. DC calibration is applicable to the Sentry 20 Plus and Sentry 30 Plus instruments.

Press [F1] = UP to go to **Cal Step 3: 'DCV 6kV Offset (50V)'**.

Press [STOP] to return instrument to steady state.

Press [START] to get offset value.

Press [F1] = INC or [F2] = DEC until the Sentry Plus display reads the same as the voltmeter.

Press [ENTER] to accept reading.

Sentry Plus reverts to "DCV Offset" display (incorporating new cal value).

Press [F1] = UP to go to **Cal Step 4: 'DCV 6kV Full (4kV)'**. Change voltmeter range to 20kV.

Press [STOP] to return instrument to steady state.

Press [START] to get full value.

Press [F1] = INC or [F2] = DEC until the Sentry Plus display reads the same as the voltmeter.

Press [ENTER] to accept reading.

Sentry Plus reverts to "DCV Full" display (incorporating new cal value).

4.3.5 IR Voltage Calibration (IRV)

Keep the setting on the Valhalla voltmeter at DC and 2kV range. IR calibration is applicable to the Sentry 30 Plus instrument.

Press [F1] = UP to go to [Cal Step 5: 'IRV 1kV Offset \(50V\)'](#).

Press [STOP] to return instrument to steady state.

Press [START] to get offset value.

Press [F1] = INC or [F2] = DEC until the Sentry Plus display reads the same as the voltmeter.

Press [ENTER] to accept reading.

Sentry Plus reverts to "IRV Offset" display (incorporating new cal value).

Press [F1] = UP to go to [Cal Step 6: 'IRV 1kV Full \(1kV\)'](#). Change voltmeter range to 20kV.

Press [STOP] to return instrument to steady state.

Press [START] to get full value.

Press [F1] = INC or [F2] = DEC until the Sentry Plus display reads the same as the voltmeter.

Press [ENTER] to accept reading.

Sentry Plus reverts to "IRV Full" display (incorporating new cal value).

4.3.6 AC Current Calibration (ACA)

Connect the OUTPUT terminal of the Sentry Plus Series instrument to a resistance box or resistance standard. Connect an AC/DC current meter in series between the resistance load (box/standard) and the RTN/LOW terminal of the Sentry Plus instrument. Table 4-3 lists the resistance loads necessary for the current calibration steps.

Table 4-3: Resistance Loads

Mode	Step #	Voltage	Calibration Point	Resistance (Load)
ACA	CAL 7	1200 V	0.12mA	10MΩ
ACA	CAL 8	1200 V	2.4mA full	500kΩ
ACA	CAL9	1200 V	2.4mA	500kΩ
ACA	CAL 10	1200 V	12mA	100kΩ
DCA	CAL 11	1200 V	0.12mA	10MΩ
DCA	CAL 12	1200 V	2.4mA full	500kΩ
DCA	CAL 13	1200 V	2.4mA	500kΩ
DCA	CAL 14	1200 V	4.8mA	250kΩ

Press [F1] = UP to go to [Cal Step 7: 'ACA 3mA Offset \(0.12mA\)'](#).

Press [STOP] to return instrument to steady state.

Press [START] to get offset value.

Press [F1] = INC or [F2] = DEC until the SPlus display reads the same as the current meter.

Press [ENTER] to accept reading.

Sentry Plus reverts to "ACA 3mA Offset" display (incorporating the new cal value).

Press [F1] = UP to go to [Cal Step 8: 'ACA 3mA Full \(2.4mA\)'](#).

Press [STOP] to return instrument to steady state.

Press [START] to get full value.
Press [F1] = INC or [F2] = DEC until the SPlus display reads the same as the current meter.
Press [ENTER] to accept reading.
Sentry Plus reverts to “ACA 3mA Full” display (incorporating the new cal value).

Press [F1] = UP to go to [Cal Step 9: ‘ACA 15mA Offset \(2.4mA\)’](#).
Press [STOP] to return instrument to steady state.
Press [START] to get offset value.
Press [F1] = INC or [F2] = DEC until the SPlus display reads the same as the current meter.
Press [ENTER] to accept reading.
Sentry Plus reverts to “ACA 30mA Offset” display (incorporating the new cal value).

Press [F1] = UP to go to [Cal Step 10: ‘ACA 15mA Full \(12mA\)’](#).
Press [STOP] to return instrument to steady state.
Press [START] to get full value.
Press [F1] = INC or [F2] = DEC until the SPlus display reads the same as the current meter.
Press [ENTER] to accept reading.
Sentry Plus reverts to “ACA 30mA Full” display (incorporating the new cal value).

4.3.7 DC Current Calibration

Connect the OUTPUT terminal of the Sentry Plus Series instrument to a resistance box or resistance standard. Connect an AC/DC current meter in series between the resistance load (box/standard) and the RTN/LOW terminal of the Sentry Plus instrument.

Press [F1] = UP to go to [Cal Step 11: ‘DCA 3mA Offset \(0.12mA\)’](#).
Press [STOP] to return instrument to steady state.
Press [START] to get offset value.
Press [F1] = INC or [F2] = DEC until the SPlus display reads the same as the current meter.
Press [ENTER] to accept reading.
Sentry Plus reverts to “DCA 3mA Offset” display (incorporating the new cal value).

Press [F1] = UP to go to [Cal Step 12: ‘DCA 3mA Full \(2.5mA\)’](#).
Press [STOP] to return instrument to steady state.
Press [START] to get full value.
Press [F1] = INC or [F2] = DEC until the SPlus display reads the same as the current meter.
Press [ENTER] to accept reading.
Sentry Plus reverts to “DCA 3mA Full” display (incorporating the new cal value).

Press [F1] = UP to go to [Cal Step 13: ‘DCA 5mA Offset \(2.4mA\)’](#).
Press [STOP] to return instrument to steady state.
Press [START] to get offset value.
Press [F1] = INC or [F2] = DEC until the SPlus display reads the same as the current meter.
Press [ENTER] to accept reading.
Sentry Plus reverts to “DCA 15mA Offset” display (incorporating the new cal value).

Press [F1] = UP to go to [Cal Step 14: 'DCA 5mA Full \(4.8mA\)'](#).
Press [STOP] to return instrument to steady state.
Press [START] to get full value.
Press [F1] = INC or [F2] = DEC until the SPlus display reads the same as the current meter.
Press [ENTER] to accept reading.
Sentry Plus reverts to "DCA 15mA Full" display (incorporating the new cal value).

4.3.8 ARC Calibration

ARC calibration is part of the calibration routine but it is **not** performed on the Sentry Plus instruments. **ARC Calibration is set at the factory. To by-pass these two steps:**

Press [F1] = UP to go to Cal Step 15: 'AC ARC 15mA (7mA)'. BY-PASS
Press [F1] = UP to go to Cal Step 16: 'DC ARC 5mA (5mA)'. BY-PASS

IR Resistor Calibration (IRR)

Connect the resistance load (per Table 4-2) between the Sentry Plus instrument's OUTPUT terminal and RTN/LOW terminal.

Press [F1] = UP to go to [Cal Step 17: 'IRR Range1 \(1GΩ\)'](#).
Press [STOP] to return instrument to steady state.
Press [START] to get range1 value.
Press [F1] = INC or [F2] = DEC until the Splus display reads the same as certified load value.
Press [ENTER] to accept reading.
Sentry Plus reverts to "IRR Range1" display (incorporating the new cal value).

Press [F1] = UP to go to [Cal Step 18: 'IRR Range2 \(100MΩ\)'](#).
Press [STOP] to return instrument to steady state.
Press [START] to get range2 value.
Press [F1] = INC or [F2] = DEC until the SPlus display reads the same as certified load value.
Press [ENTER] to accept reading.
Sentry Plus reverts to "IRR Range2" display (incorporating the new cal value).

Press [F1] = UP to go to [Cal Step 19: 'IRR Range3 \(10MΩ\)'](#).
Press [STOP] to return instrument to steady state.
Press [START] to get range3 value.
Press [F1] = INC or [F2] = DEC until the SPlus display reads the same as certified load value.
Press [ENTER] to accept reading.
Sentry Plus reverts to "IRR Range3" display (incorporating the new cal value).

Press [F1] = UP to go to [Cal Step 20: 'IRR Range4 \(10MΩ\)'](#).
Press [STOP] to return instrument to steady state.
Press [START] to get range4 value.
Press [F1] = INC or [F2] = DEC until the SPlus display reads the same as certified load value.

Press [ENTER] to accept reading.
Sentry Plus reverts to “IRR Range4” display (incorporating the new cal value).

Ground Continuity Calibration

GC 5Ω Offset (1Ω)

Connect a 1Ω load resistor between the Sentry Plus instrument’s rear panel RTN/LOW terminal and Ground Continuity Option terminal.

Press [F1] = UP to go to [Cal Step 21: ‘GC 5Ω Offset \(1Ω\)’](#).
Press [STOP] to return instrument to steady state.
Press [START] to get offset value.
Press [F1] = INC or [F2] = DEC until the Splus display reads the same as certified load value.
Press [ENTER] to accept reading.
Sentry Plus reverts to “GC 5Ω Offset” display (incorporating the new cal value).

GC 5Ω Full (3Ω)

Connect a 3Ω load resistor between the Sentry Plus instrument’s rear panel RTN/LOW terminal and Ground Continuity Option terminal.

Press [F1] = UP to go to [Cal Step 22: ‘GC 5Ω Full \(3Ω\)’](#).
Press [STOP] to return instrument to steady state.
Press [START] to get full value.
Press [F1] = INC or [F2] = DEC until the SPlus display reads the same as certified load value.
Press [ENTER] to accept reading.
Sentry Plus reverts to “GC 5Ω Full” display (incorporating the new cal value).

Contrast Calibration

This calibration step is by-passed. If setup is selected, the display contrast will be set to a level of 7. Display contrast can be adjusted as specified in paragraph 2.15.2.1.

Finalize Calibration

When all calibration steps are complete:

Press [F4] = EXIT

Release the [CAL] enable switch to the **OUT** position using the tip of a small screwdriver.

1. Press [F2] = DOWN three times.
2. Press [F3] = SELECT
3. Display prompts: ‘PASSWORD’.
4. Press [A] [A] [A] [A] [ENTER]
5. Display prompts: ‘Select Software Calibration?’
6. Press [F1] = ON to set Calibration Values ON.